

Integrating Safe Water, Sanitation, and Hygiene into Infant and Child Nutrition Programmes

A Training and Resource Pack for Uganda

NOVEMBER 2014



© 2014 FHI 360. All rights reserved. Any part of this manual can be adapted provided the source is acknowledged.

WASHplus
1825 Connecticut Avenue, NW
Washington, DC 20009-5721
www.washplus.org

The WASHplus project supports healthy households and communities by creating and delivering interventions that lead to improvements in water supply, sanitation, and hygiene and household air pollution. This five-year project (2010-2015), funded through USAID's Bureau for Global Health (AID-OAA-A-10-00040) and led by FHI 360 in partnership with CARE and Winrock International, uses at-scale as well as integrated programming approaches to reduce diarrheal diseases and acute respiratory infections, the two top killers of children under age five globally.

Suggested citation: USAID/WASHplus Project, 2014. Integrating Water, Sanitation, and Hygiene into Child Nutrition Programmes: A Resource Pack for Uganda. Washington DC: FHI 360.

Table of Contents

ABOUT THE MANUAL	2
Acronyms.....	3
Acknowledgements	4
Introduction and Context	5
How to Use This Resource Pack.....	7
MODULE I: TWO-DAY BASIC TRAINING FOR COMMUNITY LEVEL RESOURCE PERSONS	10
Session 1: Introduction to the Training	13
A. Introducing Participants.....	13
B. Purpose of the Workshop	13
C. Introducing the Training Schedule	15
Session 2: Why WASH Matters in Infant and Child and Nutrition	16
A. The Importance of Drinking Clean Water, Using Latrines, and Washing Hands...	16
B. The Consequences of Poor Hygiene Practices	18
Session 3: Blocking Fecal Contamination	20
A. Contamination Routes	20
B. How to Prevent Contamination of the Surroundings.....	22
Session 4: WASH Behaviours	26
A. Explaining Behaviour and Behaviour Change	26
B. Four Tools to Block Fecal-Oral Contamination	27
C. Factors that Influence Behaviour Change	27
Session 5: Hand Washing	29
A. The Importance of Hand Washing	29
B. Current Hand Washing Practices	31
C. The Correct Way to Wash Hands	31
D. When to Wash Hands	32
E. Making a Tippy Tap for Hand Washing.....	34
F. The Benefits of a Tippy Tap.....	35

Session 6: Improving WASH Behaviours through Small Doable Actions	37
A. Introducing the Concept of Small Doable Actions	37
B. Negotiating Small Doable Actions.....	38
C. Qualities and Skills of a Good Communicator.....	40
D. Listening and Body Language Skills.....	41
Session 7: Keeping Drinking Water Safe from Source to Mouth	42
A. The Links in the Water Safety Chain	42
B. Ensuring Water Remains Safe to Drink	43
Session 8: Action Planning	45
A. Small Doable Actions to Promote WASH	45
B. Action Plan to Promote the Identified Small Doable Actions	45
Module I Evaluation	47
Module I Handouts	48
MODULE II: EXTENDED ONE-DAY TRAINING FOR COMMUNITY LEVEL RESOURCE PERSONS	66
Session 1: Water Treatment Methods	68
A. Do We Need to Treat Water for Drinking if It Looks Clean?.....	69
B. Filtering.....	69
C. Boiling	70
D. Solar Disinfection	71
E. Chlorine	72
F. Advantages and Disadvantages of the Different Methods.....	75
Session 2: WASH and Food Hygiene	77
A. The Link between WASH and Safe Food	77
B. Understanding the Food Chain	78
C. How to Keep Food Safe.....	78
D. Identifying Small Doable Actions to Promote Food Hygiene	80
Session 3: Improving WASH Programmes	81
A. Documenting and Monitoring WASH Activities	81
B. Self Reflection to Improve Skills.....	82
Module II Evaluation	84

Module II Handouts	86
MODULE III: HALF-DAY SEMINAR FOR POLICY AND DECISION MAKERS TO SUPPORT THE INTEGRATION OF WASH INTO NUTRITION PROGRAMMES	94
Session 1: Introduction to the Seminar	96
A. Introducing Participants.....	96
B. Purpose of the Seminar	96
C. Introducing the Seminar Schedule.....	97
Session 2: Why WASH Matters in Infant and Child Nutrition	98
A. Basic Concepts and Importance of Good Nutrition	98
B. The Link between Nutrition and Diarrhoea	99
Session 3: Blocking Fecal Contamination	100
A. Contamination Routes	101
B. How to Prevent Contamination of the Surroundings.....	103
Session 4: Small Doable Actions Approach	106
A. Introducing the Concept of Small Doable Actions	106
B. Small Doable Actions for WASH	107
Session 5: Supporting the Integration of WASH into Nutrition Programmes	109
A. Roles in Supporting Lower Level Cadres	109
B. Developing an Action Plan	110
Module III Handouts	112
WASH INTEGRATION JOB AIDS	124



About the Manual

Acronyms

CKW	Community Knowledge Worker
CLTS	Community Led Total Sanitation
HIV	Human Immunodeficiency Virus
IYCF	Infant and Young Child Feeding
MOH	Ministry of Health
NACS	Nutrition Assessment, Counseling, and Support
PHAST	Participatory Hygiene and Sanitation Transformation
PSG	Peer Support Group
SDA	Small Doable Action
SODIS	Solar Disinfection
TB	Tuberculosis
UDHS	Uganda Demographic and Health Survey
USAID	United States Agency for International Development
VHT	Village Health Team
WASH	Water, Sanitation, and Hygiene
WHO	World Health Organization

Acknowledgements

This Republic of Uganda Ministry of Health (MOH) publication was prepared with financial and technical support from the WASHplus project with funding from the United States Agency for International Development (USAID). The programme would like to recognize Mariella Ruiz-Rodriguez and Alfred Boyo, USAID/Uganda, for their commitment to WASH Integration in Uganda. This activity would not have been possible without the dedicated support of the USAID implementing partners, SPRING (Strengthening Partnerships, Results, and Innovations in Nutrition Globally), STAR-SW (Strengthening TB and HIV/AIDS Response in the Southwest), and Community Connector (all staff but particularly Asiimwe Charles and Robert Mwadime for their leadership, Dan Nabaasa for integrating WASH in the BCC community Groups and Miria Twinomugisha the Nutritional Fellow for assistance with pretesting the training). In addition, we recognize the dedicated teams in local government including the District Chief Administrative Officers, District Health Inspectors, District Health Educators and nutritional focal persons of Kisoro, Kanungu, and Kabale. They are committed and integral partners and have helped to bring this activity to the districts of Uganda and ultimately to the communities themselves.

The training was adapted from previous work of the WASHplus project in other countries by team members of the USAID/WASHplus Project and our predecessor project USAID/ Hygiene Improvement Project, including Renuka Bery, Julia Rosenbaum, Eleonore Seumo, and Elizabeth Younger. Juliet Nandawula and Julia Rosenbaum revised this capacity building material with the assistance of consultant John Odolon, FHI360's Dawn McCown, and with support from selected district health officers/inspectors, village health teams, and peer educators through the MOH and USAID implementing partners Community Connector, STAR-SW, SPRING, and others. We acknowledge the significant contribution of FHI360's Dawn McCown who graphically designed this training guide, as well as Paul Kasobya who designed the related WASH job aids, illustrator Justin Igala, and Wendy Putnam for graphics and editorial work (WASHplus).

It is the intent that this training helps to strengthen key competencies of a range of stakeholders to support and carryout initiatives integrating WASH into nutrition programmes, with the overall goal of improving the growth and well-being of Uganda's infants and young children; leaving them strong and resilient to grow and thrive into innovative, educated, and productive adults. A packet of job aids accompanies this training to facilitate outreach workers and counselor to integrate WASH into nutrition initiatives.

Kampala, November 2014

Introduction and Context

Globally, nutrition plays a crucial role in the health and socioeconomic development of any country. Malnutrition accounts for about 35 percent of deaths among children under 5 years old around the world. Stunting, severe wasting, and intrauterine growth retardation are the major contributors to child mortality, accounting for about 2 million deaths annually. Malnutrition is a major cause of morbidity for all age groups, accounting for 11 percent of the disease burden globally. In addition, iron deficiency is the leading cause of maternal mortality, accounting for 20 percent of the estimated 536,000 deaths worldwide. About 43 percent of all deaths among children under 5 occur in Africa.¹

Diarrhoea and Stunting

A vicious cycle links diarrhoea and under-nutrition. Diarrhoea is associated with poor nutritional status. Poor nutritional status is also associated with greater risk of diarrhoea (Briend, 1990; Checkley et al, 2002). Recent analysis of 9 studies (Checkley et al, 2008) shows that odds of stunting at age 24 months increased with each diarrhoeal episode before 24 months. The odds of stunting at age 24 months increased by 1.13 (95% C.I. 1.07, 1.19) for every five episodes of diarrhoea. Further, studies show high diarrhoeal disease burdens before 24 months are linked with delayed school entry and poorer performance on intelligence tests (Patrick et al 2005, Lorntz et al 2006). Among the water, sanitation, and hygiene (WASH) supportive interventions, hand washing with soap reduces diarrhoea morbidity by 48%. Another supportive intervention, water treatment, reduces diarrhoea morbidity by 17%².

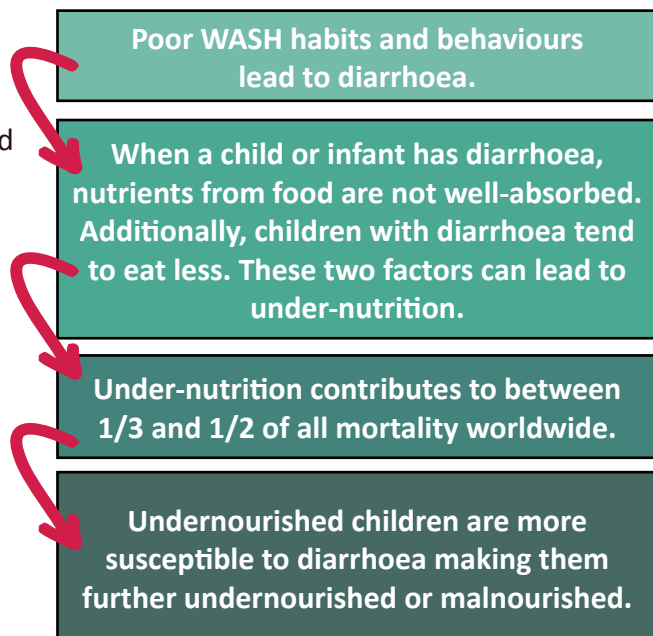

In Uganda, malnutrition leads to stunting and wasting in children under the age of 5. Undernourished children are more susceptible to diarrhoea especially in situations where there are poor practices in sanitation and hygiene. According to the Uganda Demographic and Health Survey (UDHS 2011), 38% of children age 6-59 months, and 36% of women age 15-49 have vitamin A deficiencies. Only 6% of children age 6-23 months are fed appropriately, based on the recommended infant and young child feeding (IYCF) practices. Further, 49% percent of children age 6-59 months are anaemic, 22% are mildly anaemic,

26% are moderately anaemic, and 2% are severely anaemic.

The large number of vitamin A deficiencies, inappropriate feeding practices, and widespread anaemia is a reflection of the significant proportion of young children in Uganda today who are still chronically malnourished. Malnutrition has led to 33% of children under age 5 being stunted, and 14% of children under age 5 being severely stunted. On weight for height, overall, 5% of Ugandan children are wasted, and 2% are severely wasted. It is during the ‘window of opportunity’—the 1,000 days from conception through the child’s second birthday— that the greatest damage occurs but the window also presents the greatest returns on effective action to prevent malnutrition.

Objective of this Resource Pack

The overall objective of this Resource Pack is to facilitate the training of village health teams (VHTs), community knowledge workers (CKWs), peer support groups (PSGs), and other outreach workers on how they can help household and community members to overcome, or change, the many daily obstacles to improved water, sanitation, and hygiene (WASH) practices in the home. It is based on the principle that new practices can be adopted and current practices can be modified or changed in small ways that are acceptable to the householder. These small changes will make a difference to reduce diarrhoea and improve families’ health and well-being. This Resource Pack is part of the WASHplus project’s effort to compliment targeted nutrition support by the ministry of health (MOH) to selected districts and health facilities using the Nutrition Assessment and Counselling and Support (NACS) approach.

¹ NACS Manual, SPRING/MOH Uganda.

² Bhutta Z.A. · Das J.K. Black RE, Singhal A, Uauy R (eds): International Nutrition: Achieving Millennium Goals and Beyond. Nestlé Nutr Inst Workshop Ser. Nestec Ltd. Vevey/S. Karger AG Basel, © 2014, vol 78, pp 59-69;

How to Use This Resource Pack

Who Should Facilitate the Trainings?

Facilitators should be trained or experienced trainers and familiar and comfortable with a highly participatory approach to learning. At least one member of each training team must be trained and experienced in the Community-led Total Sanitation (CLTS) or Participatory Hygiene and Sanitation Transformation (PHAST) approach. It is recommended that all facilitators have experience with WASH in Schools or other community WASH or education programmes. Each training should be carried out by a team of two facilitators.

How the Resource Pack is Organized

The back of this resource pack contains a copy of WASHplus's job aids that were developed to assist village health teams, peer educators and their supervisors integrate WASH into ongoing nutrition activities in Uganda. Many of the handouts throughout the trainings are replicates of these job aids, giving participants hands on experience working with these tools.

Following the job aids, the resource pack is broken into three modules. Module I is designed for health workers. Module I combined with Module II is designed for community level resources persons. Module III is designed for policy stakeholders and decision makers.

Module I is a two-day training designed for training sub-county level health workers who conduct health education at the facility (health assistant, clinical officer, nurse, midwife), community development officers, and staff of nutrition projects.

Module II is a one day supplement to Module I. It is a three-day training designed for community level resource persons, including VHTs, CKWs, PSGs, drama groups and community volunteers. Module II includes all the material of Module I plus the essential sessions on the methods for treating water to make it safe for drinking and food hygiene.

Module III is a half-day orientation on WASH and nutrition targeting various decision and policy makers at district and sub county level.

Where possible, it is vital to have a balance of both males and females in each training or orientation. The trainee group should not be bigger than 30 people to allow for conversation and interaction. Carrying out this training with "mixed" groups of health, education, sanitation, water and sub county leadership is vital to the success of the training because integration of WASH into nutrition depends upon the interaction and "buy in" of various stakeholders. The learning and planning sessions should happen together, so that each group understands its role and the interdependent nature of integrated WASH and nutrition behaviour change.

All modules have easy-to-follow instructions for the facilitator. Before each training, the facilitator should become familiar with the modules and prepare the necessary materials. The objectives, needed materials and preparation, and estimated time for completion are outlined at the beginning of each session. Handouts are included for all sessions. Facilitators should use their judgment on photocopying or reproducing the handouts on a flip chart. Decisions will depend on available budget, materials, and technical support.

Venue

While budget and location influence venue selection, a secluded venue facilitates participant focus and attendance, as it's less possible to "come and go" during sessions. A room with comfortable temperature, at least two walls for flipcharts with table and chairs is ideal.

Preparation and materials needed

Each session outlines the materials or items that the facilitator will need to effectively deliver the session. In most cases, the facilitator will need to make preparations in advance. A complete list of materials and handouts needed for each session is detailed in the overview at the beginning of each module:

- ◆ Module I Training Materials List - Page 9
- ◆ Module II Training Materials List - Page 65
- ◆ Module II Training Materials List - Page 93

While each session may require different types of preparation, facilitators will need these basics for all sessions:

- ◆ 2 flip chart stands
- ◆ Flip chart paper
- ◆ Different colored markers
- ◆ Tape to put flip charts on walls

Module I

Integrating WASH into Infant and Child Nutrition Programmes

Two-Day Basic Training for Health Workers and
Community Level Resource Persons

Module I

Overview

Target

Module I is a two-day training designed for sub county level health workers and community level resource persons including VHTs, CKWs, PSGs, drama groups, community volunteers, health education staff at clinics, and staff working on nutrition programmes.

Workshop Objectives

By the end of the module participants will be able to:

1. Explain why WASH matters for the growth of infants and young children
2. Demonstrate how and when to correctly wash hands
3. Build and teach others how to construct a tippy tap
4. Describe key WASH behaviours needed to block oral-fecal transmission
5. Analyze a house and apply a small doable action approach to changing WASH behaviours
6. Demonstrate how to keep water safe through each step of the water safety chain
7. Develop an action plan for WASH behaviour change interventions in their community
8. Review and examine the pack of job aides for integrating WASH into nutrition activities

Training Materials

SESSION 1

- ◆ Picture Card: Family Comparison
- ◆ Prepared Flip Chart: Workshop objectives
- ◆ Handout 1: Training schedule

SESSION 2

- ◆ Handout 2: The Sad Tale of Kiconco

SESSION 3

- ◆ Picture Card: Person Practicing Open Defecation
- ◆ Prepared flip chart: Feet, Flies, Fingers, Fields, Fluids, Food
- ◆ A4 papers, cut in half or blank cards
- ◆ Markers and tape for each group

SESSION 4

- ◆ Handout 3: Factors that Influence WASH Behaviours

SESSION 5

- ◆ Turmeric powder, chalk powder or glitter
- ◆ Basin, water, and soap
- ◆ Handout 4: How to Wash Hands Correctly
- ◆ Handout 5: Hand Washing Calculations
- ◆ Handout 6: Different Types of Tippy Taps
- ◆ Handout 7: Instructions for Making a Tilting Jerry Can Tippy Tap

- ◆ Materials for groups to make a tippy tap
 - Plastic 1/1.5 litre water bottles AND/OR gourds AND/OR 5-litre jerry can
 - Pen casings AND/OR papaya stems AND/OR straws (anything that is hollow)
 - Sharp knives AND/OR nails and candles AND/OR screwdrivers

SESSION 6

- ◆ Handout 8: Guiding Principles for Negotiating Multiple WASH Needs
- ◆ Introduction and Instructions from Job Aid Pack

SESSION 7

- ◆ Handout 9: Water Safety Chain
- ◆ Handout 10: Taking Care of Drinking and Cooking Water
- ◆ Handout 11: Cleaning Drinking Water Storage Containers

SESSION 8

- ◆ Handout 12: Action Planning Template
- ◆ Handout 13: Small Doable Actions for WASH

MODULE I EVALUATION

- ◆ Handout 14: Workshop Evaluation

Workshop Schedule at-a-Glance

DAY 1		DAY 2	
9:00-9:30	Session 1: Introduction to the Training	9:00-9:30	Recap of Day 1
9:30-10:30	Session 2: Why WASH Matters in Infant and Child Nutrition	9:30-10:00	Session 5: Hand washing (cont.)
10:30-11:00	Tea Break	10:00-10:30	Tea Break
11:00-12:30	Session 3: Blocking Fecal Contamination	10:30-12:30	Session 6: Improving WASH Behaviours through Small Doable Actions
12:30-1:30	Session 4: WASH Behaviours	12:30-1:30	Lunch Break
1:30-2:30	Lunch Break	1:30-2:30	Session 7: Keeping Drinking Water Safe from Source to Mouth
2:30-4:30	Session 5: Hand Washing	2:30-4:00	Session 8: Action Planning
4:30-4:45	Tea Break	4:00-4:15	Tea Break
4:45-5:00	Close	4:15-4:45	Close & Evaluation

MODULE I SESSION PLANS

Session 1: Introduction to the Training

Session Learning Objectives

By the end of the session participants will be able to:

1. Describe the purpose of this training

Prep Work

Prepare and Bring Supplies

- ◆ Picture Card: Family Comparison
- ◆ Prepared Flip Chart: Workshop objectives (objectives are on page 35)
- ◆ Handout 1: Training schedule

Time

30 minutes

Trainer Steps: Introduction to the Training

A. Introducing Participants (10 Minutes)

1. Introduce yourself by name, job function, and place of origin, sub county you represent (if appropriate), and one behaviour CHANGE that YOU personally have tried to make in the past year, successful or unsuccessful.
2. Explain that we are talking about improving WASH and nutrition behaviours and about supporting people to make changes so it helps to think about changes we have tried to make ourselves as we ask others to make changes.
3. Hand a ball to a participant and ask him/her to introduce themselves the same way you did. After they are done introducing themselves ask them to throw the ball to another participant who will introduce them self in the same manner. Continue throwing the ball from participant to participant until everyone has had a chance to introduce themselves.

B. Purpose of the Workshop (10 Minutes)

1. Present the purpose of this workshop on a flip chart, which is to improve the WASH behaviours related to nutrition. Ask, what do we mean by WASH? Say Water, sanitation, and hygiene or hand washing. WA for water, S for Sanitation, H for hygiene or hand washing, All together....WASH!!

2. Ask what do we mean by WASH-friendly? Elicit responses and let the group know that we'll be talking about that in the next session, and throughout the entire training.

A WASH-Friendly community is one where the whole community carries out the following three key hygiene practices:

1. Using improved sanitation facilities
2. Washing hands with soap or ash at critical times (after using toilets, before eating, and before feeding)
3. Drinking safe water that has been treated, stored, and retrieved properly
4. Practicing safe food preparation, cooking, and storing

3. Explain the basic concepts of 'Nutrition'.

Nutrition is a process of taking in and digesting food. The food is used for growth, reproduction, immunity, breathing, work, and health. The food is stored as nutrients and energy in appropriate parts of the body.

Malnutrition is an imbalance in nutrition status; and can be either over-nutrition or under-nutrition.



FACT BOX

In Uganda, only one in eight (13 percent) children age 6-23 months were fed according to minimum standards with respect to food diversity (four or more food groups). Overall, only 6 percent of the youngest children age 6-23 months living with their mothers are fed in accordance with 3 IYCF practices – UDHS 2011

4. Explain that this training will focus on the issues surrounding diarrhoea, how we can help control and prevent it, and support healthy child growth.
5. Hold up Picture Card: Children Comparison. Explain that in this card there are several children, all between the ages of 7-9 but they look different. Ask the participants: How do they look different? and What could have caused this?
Possible Answers:
- ◆ Malnourished mother
 - ◆ Poor diet (inadequate weaning foods)
 - ◆ Diarrhoea
 - ◆ Genetics
6. Discuss diarrhoea and the consequences of under nutrition on infants and children during the first 1,000 days. Explain stunting and wasting as outlined in the following text boxes.

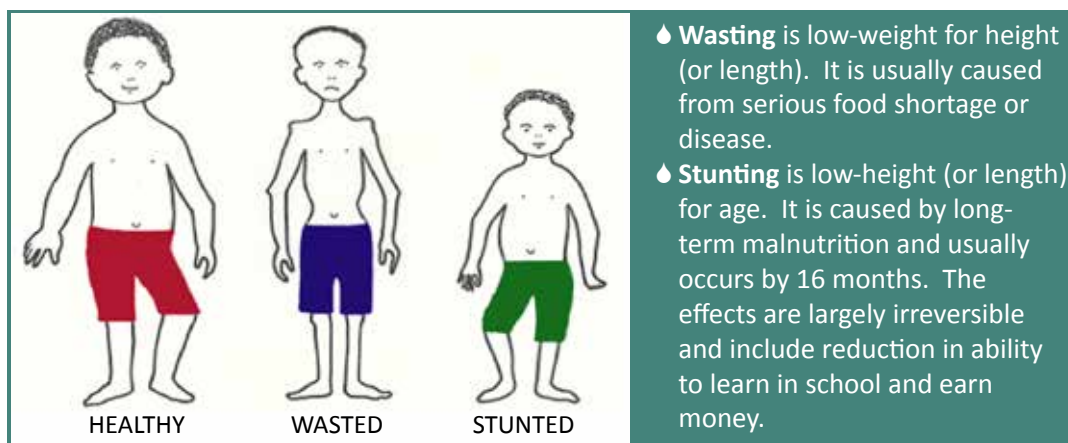

Emphasize that it is critical to promote optimal growth, health and development for all infants from birth to 2 years of age (i.e. the first 1000 days of infant's life). Poor nutrition and WASH practices and high rates of infections have a detrimental impact on health and growth during these important years.

Growth faltering and stunting starts when food is introduced. Stunting is low height for age and results from chronic undernutrition and affects not only height but brain and emotional development. Most stunting happens during months 4-16 and is basically irreversible and limits potential for life. In addition to limiting stature, stunting affects intellectual and economic potential!

For the best possible infant health and development outcomes, all mothers, must adopt optimal infant feeding practices that maximize protection against early childhood illnesses.³

7. Present the training objectives for the workshop (found on page 35 of this manual) on a flip chart and answer any questions. Some terms might be unfamiliar, so ask what words the participants do not understand and explain them. Also explain that these words will become familiar during the two days together.

C. Introducing the Training Schedule (10 Minutes)

1. Present the training schedule on a flip chart or pass out Handout 1 and explain the activities for each session starting at the beginning and answer any questions. Explain timing for each session and the total time available for training (two days). If time is tight, it is possible to ask participants if they want to have one working tea each day and/or cut lunch from 60 to 45 minutes.
2. Review and resolve all logistical arrangements (meals, lodging, per diem, transportation, etc.).
3. Explain how we'll spend the next two days: We will review the current WASH conditions in communities, learn what we can do to improve them, and understand why it is important. We'll work in stakeholder groups and then together plan how to make communities WASH-friendly.

³WHO Guidelines on HIV and Infant Feeding, 2010.

MODULE I SESSION PLANS

Session 2: Why WASH Matters in Infant and Child Nutrition

Session Learning Objectives

By the end of the session participants will be able to:

1. Explain why diarrhoea is dangerous for children 0 – 24 months old
2. Describe the consequences of poor hygiene practices for young children

Prep Work

Prepare and Bring Supplies

- ◆ Handout 2: The Sad Tale of Kiconco

Time

60 minutes

Trainer Steps: Why WASH Matters in Infant and Child Nutrition

A. The Importance of Drinking Clean Water, Using Latrines, and Washing Hands (20 Minutes)

1. Introduce the session by saying that we are going to be talking a lot about feces/ defecation and problems associated with feces in the environment, how this affects community members especially children and infants (0 – 24 months old), and also about solutions that we can devise with our own resources.



TRAINERS NOTE

This topic gets people thinking about and understanding the problem of open defecation and the importance of barriers (latrines, clean hands, safe water) to fecal contamination.

2. Ask participants where most people take care of defecation. Women? Small children? In fields? Why do people “go to the bush”? Do you think it is a problem? Why or why not? What are some bad things that can happen when people defecate in the open?

Possible answers:

- ◆ Feces are dangerous to our health
- ◆ Feces get into our food, water, hands and then into our mouths

- ♦ Feces carry diseases and makes us sick
 - ♦ It's disgusting to see and very unpleasant to smell
 - ♦ Flies
 - ♦ Embarrassment or assault on females
3. Ask participants what are some sicknesses you know that can come from contact with feces that are deposited in the open?
Possible answers:
- ♦ Diarrhoea/dysentery
 - ♦ Cholera
 - ♦ Worms
4. Ask participants what is so bad about diarrhoea? Is it inevitable?
5. Ask participants who is the most vulnerable to impacts of diarrhoea?
Possible answers:
- ♦ Young children
 - ♦ People living with HIV
6. Around the world and here in our villages, we see an increase in diarrhoea in young children aged 3-15 months. Why do you think that is?
Possible answers:
- ♦ They start eating and drinking and often it's contaminated
7. Explain that with diarrhoea, kids grow poorly because they lose nutrients. Stunted children are not just shorter, their brain function is also limited. They do worse in school, earn less, and are less resourceful and resilient to solve life's challenges.

A stunted child will never learn or earn their full potential vs. if they were not stunted.

FACT BOX

- ♦ Malnutrition is a public health problem in Uganda with the most vulnerable populations being women, young children, and people with chronic diseases including Human Immuno Deficiency Virus (HIV), Tuberculosis (TB).
- ♦ In Uganda, malnutrition has led to 33% of children under 5 age being stunted and 14% being severely stunted.
- ♦ When children are introduced to food at 3 – 6 months they are more likely to develop diarrhoea. This is mainly due to poor food handling and hygiene.
- ♦ A vicious cycle ensues:
 1. Children with diarrhoea tend to eat less.
 2. With diarrhoea, nutrients from food are not well-absorbed.
 3. Undernourished children are more susceptible to diarrhoea.



8. Highlight the important causes of mortality for children under 5 as shown in the pie chart. Emphasize the following points:

Causes of Mortality for Children Under 5

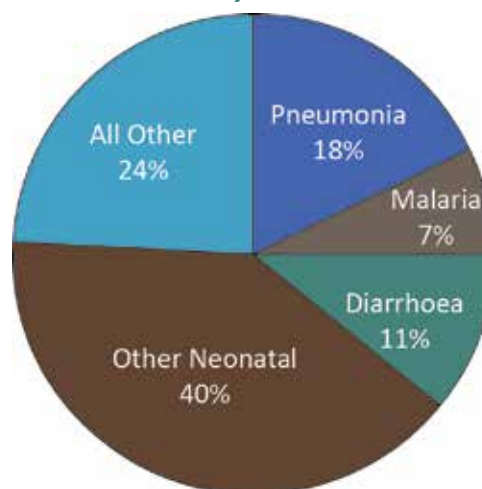

- ◆ Diarrhoea causes 11% of all child deaths and is the leading cause of malnutrition and under-nutrition. Under-nutrition contributes 1/3 to 1/2 of all mortality for children under 5 (WHO reports).
- ◆ Malnourished children suffer from irreparable stunted physical growth. Hungry children make poor students and are prone to drop out of the educational system.
- ◆ A stunted child will never learn or earn their potential vs. if they were not stunted.
- ◆ Stunted children are more likely to be ill, increasing the strain on hospitals and clinics.
- ◆ The cycle of poverty continues: Malnourished, stunted women give birth to low birth weight babies, transferring the broad economic disadvantages of malnutrition in their own lives to the next generation.
- ◆ The costs of malnutrition to the government take money away from other areas of development and hurt Uganda’s chances to thrive.

B. The Consequences of Poor Hygiene Practices (40 Minutes)

1. Explain that we will now look further into the dangers of feces contamination, bad hygiene and sanitation practices, and most importantly, how to stop them.
2. Pass out Handout 2 and have volunteers each read a paragraph of “The Sad Tale of Kiconco” to the group, tell them to listen carefully and think about whether the things that happen in the story are common and what their own experiences have been. After the story they will answer some questions.
3. Ask Participants these (or similar) questions based on the story:
 - ◆ Is this a common story? Ask 1-2 participants who said yes to tell their stories.
 - ◆ What possible conditions actually caused Kiconco’s illness?
 - ◆ Where do you think she got the disease?
 - ◆ Could it have been prevented? How?
 - ◆ Who do you think is/are responsible to change conditions so that children like Kiconco will not die?
 - ◆ What role do you think that household members have to play in preventing the illnesses?

Possible answers:

- ◆ Children/infants spend many hours playing together and are in close contact—feces can be spread more easily.
 - ◆ Children who have diarrhoea or worms can't learn well and often stay home sick.
4. Review what has emerged from the session on WASH problems, and ask participants to help you make a list of the extent of the WASH problem on a flip chart labeled "How Bad is the Problem?" including:
 - ◆ Bad practice of open defecation leads to feces getting into food and being consumed
 - ◆ Consequences of WASH-related illness in young children (for example, low level of learning, many absences from school due to illness, passing infections at home from one person to another)
 5. Explain that this is what we call the vicious cycle:
 - ◆ With diarrhoea you are less able to absorb nutrients and have less of an appetite, which leads to malnutrition
 - ◆ Once a child is malnourished, they are more vulnerable and susceptible to more diarrhoea and further malnutrition
 6. Wrap up by saying that the "Sad Tale of Kiconco" is meant to highlight the consequences of poor sanitation and hygiene behaviour as shown by the Kanyesigyes in the story. Such consequences include the high cost of treatment and can even result in death! There are solutions including avoiding open defecation as well as other measures. We have already started to talk about them in this training, and now we will learn, think about, and plan solutions in detail.

MODULE I SESSION PLANS

Session 3: Blocking Fecal Contamination

Session Learning Objectives

By the end of the session participants will be able to:

1. Explain the routes that feces take from one person to another as a result of open defecation (contamination routes)
2. Identify the key barriers for blocking the “F” routes of fecal contamination

Prep Work

Prepare and Bring Supplies

- ◆ Picture Card: Person practicing open defecation
- ◆ Prepared flip chart: Feet, Flies, Fingers, Fields, Fluids, Food written down the middle in a landscape orientation (see illustration)
- ◆ A4 papers, cut in half lengthwise or blank cards
- ◆ Markers and tape for each group

Time

90 minutes

Trainer Steps: Blocking Fecal Contamination

A. Contamination Routes (45 Minutes)



TRAINERS NOTE

This session can be done in small groups, or in plenary in an interactive discussion. Breaking into small groups takes more time, but allows participants to be more involved. Doing the exercise in plenary saves time.

1. Tell participants that we have examined the problem of the practice of open defecation and begun to look at what the consequences are of this practice on the health and well-being of adults, children and infants in the home.
2. Remind participants that feces left in the open means that:



EVERYONE IS EATING EACH OTHERS FECES!

3. Show participants the picture of the person practicing open defecation and ask:

- ◆ What happens when someone defecates in the open?
- ◆ Where do the feces go?
- ◆ What happens when it rains?
- ◆ How do the feces get from this person or that spot into our mouths to make us sick?

Possible answers:

- ◆ The rain carries feces into fields and streams and ponds. People drink contaminated water.
 - ◆ People can walk through fields and track the feces into homes.
 - ◆ Flies can land on the feces and then land on food.
 - ◆ Hands can touch the feces and then touch others, or touch food.
4. Show the flip chart paper you prepared with the six “F” words written on it like the chart below. This will be our F-Diagram.

F-Diagram

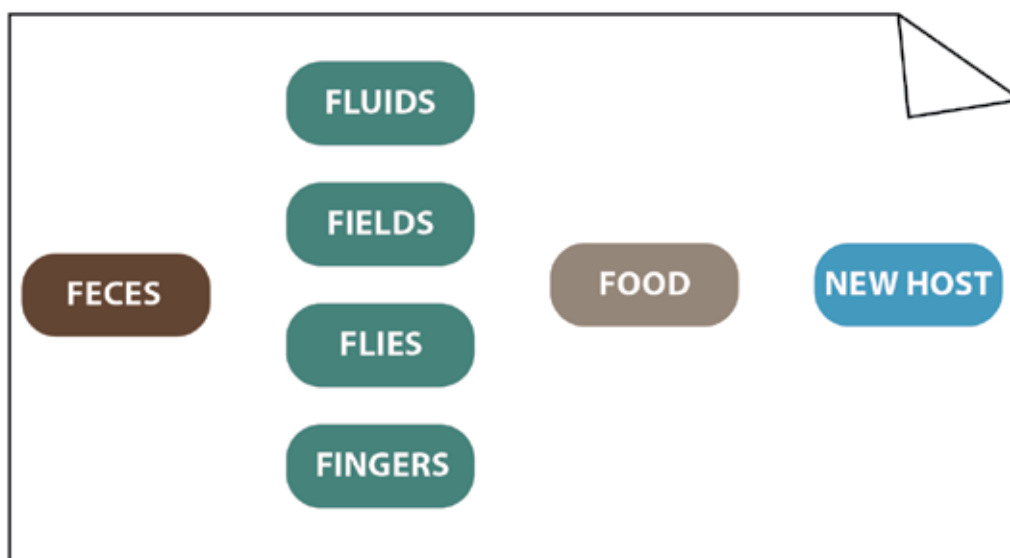

Source: Wagner and Lanois, 1958

5. Tape the open defecation picture to the left of the six “F” words written on the flip chart, where it says feces.
6. Explain that the F-Diagram (above) is an easy way to remember the routes that feces can take from one person to another and into our mouths. In more technical terms, it is called FECAL-ORAL CONTAMINATION. It represents the path in which germs can spread from person to person. Act this out dramatically to make the point. Point to your own backside and say FECAL. Bring your hand to your mouth and say ORAL. Repeat. Make it like a chant. Repeat 4-5 times.
7. Ask participants to give an example of feces transmission from one person to another for each “F”. As participants give answers, draw in the corresponding arrows on the flip chart F-diagram like the graphic below.

Possible answers:

- ◆ FLIES: land on feces, then land on uncovered food
- ◆ FINGERS: touch feces after defecation, then touch food or other people
- ◆ FIELDS: people step in it or encounter it when farming
- ◆ FLUIDS: runoff from fields and open defecation spots can go into streams where people get water and it gets on your hands; drinking water is stored unsafely and gets contaminated
- ◆ FOOD: can be contaminated by unwashed hands (fingers) or by flies landing on it

F-Diagram: Possible Fecal-Oral Contamination Routes

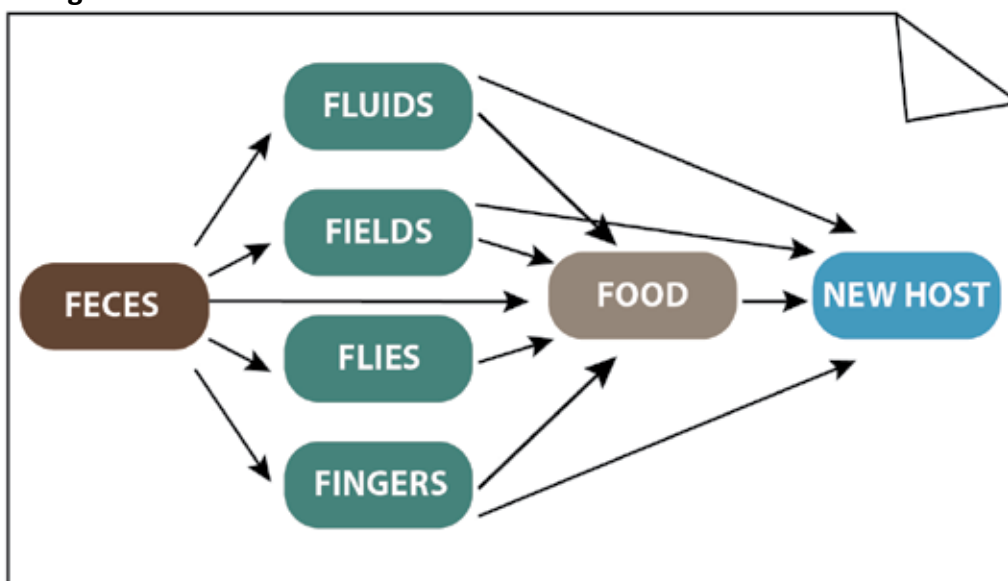

Source: Wagner and Lanois, 1958

8. Emphasize FECAL (and point to your rear) –ORAL (point to your mouth) CONTAMINATION. Repeat: FECAL (and point to your rear) –ORAL (point to your mouth) CONTAMINATION.

TRAINERS NOTE

This is a serious topic, but you can make this fun!

B. How to Prevent Contamination of the Surroundings (45 Minutes)



GROUP ACTIVITY

1. Restate that the F Diagram can also help us think of ways to block these contamination routes.
2. Divide participants into small groups of four to five persons.
3. Hand out six pieces of cut A4 paper or six cards and a marker per group.
4. Ask each group to discuss what could prevent the spread of feces into our food and water supply?

5. Tell each group to think of and discuss different ideas for blocking each “F” pathway and write down one key blocking or prevention behaviour for each pathway on each of the six cards.
6. When groups have finished, ask one group to select and tape one prevention behaviour written on the card onto the F-Diagram flip chart paper to block the corresponding “F” feces transmission route.

F-Diagram: Primary Prevention Interventions

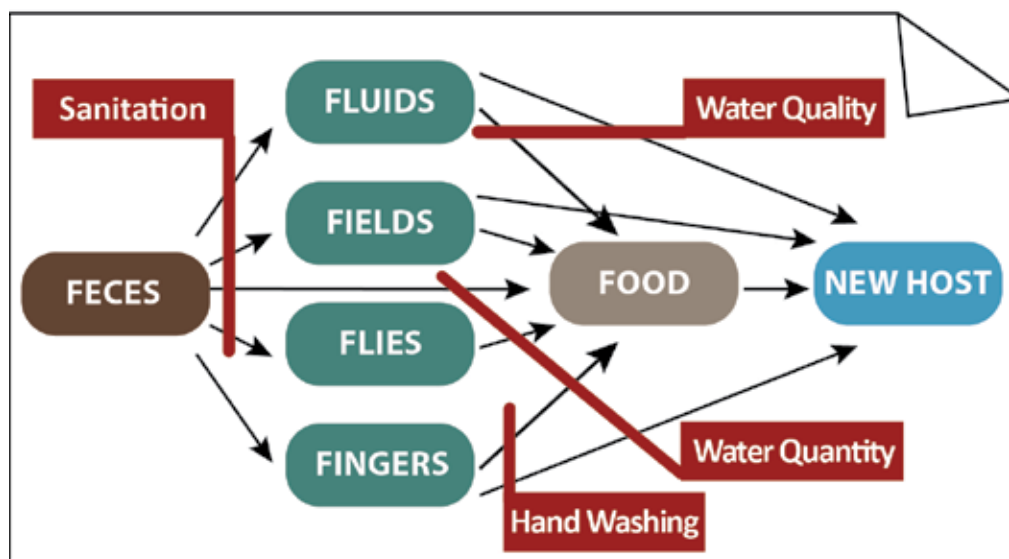

Source: Wagner and Lanois, 1958

7. Tell other groups to place a different response to “block” the other “F” transmission routes. Use the “F-Diagram: Primary Prevention Interventions” below to ensure all feces transmission routes have been properly blocked.
8. Possible prevention behaviours:
 - ◆ Proper latrine construction and use ... label “LATRINES”
 - ◆ Proper hand washing with soap/ash after defecation Label “HAND WASHING w/ SOAP”
 - ◆ Proper drinking water treatment and storage ... label “SAFE WATER”
 - ◆ School compound sanitation, drainage, and proper waste management
 - ◆ Proper washing of raw fruits and vegetables ... label “FOOD HYGIENE”
 - ◆ Proper washing and storage of food utensils ... label “FOOD HYGIENE”
 - ◆ Hand washing before preparing/eating food ... label “HANDWASHING WITH SOAP”
9. Discuss the potential benefits of the different interventions using the diagram below. Mention possible actions which householders can do in each primary prevention intervention to improve infant and child health such as:
 - ◆ Use a latrine;
 - ◆ Wash your hands after defecating, before preparing food, before eating or

- feeding someone, after cleaning a baby’s bottom;
- ♦ Safely treat your water, serve it and store it; and
- ♦ Ensure an adequate supply of water in the home for hand washing and food hygiene.

F-Diagram: Primary Prevention Intervention Benefits

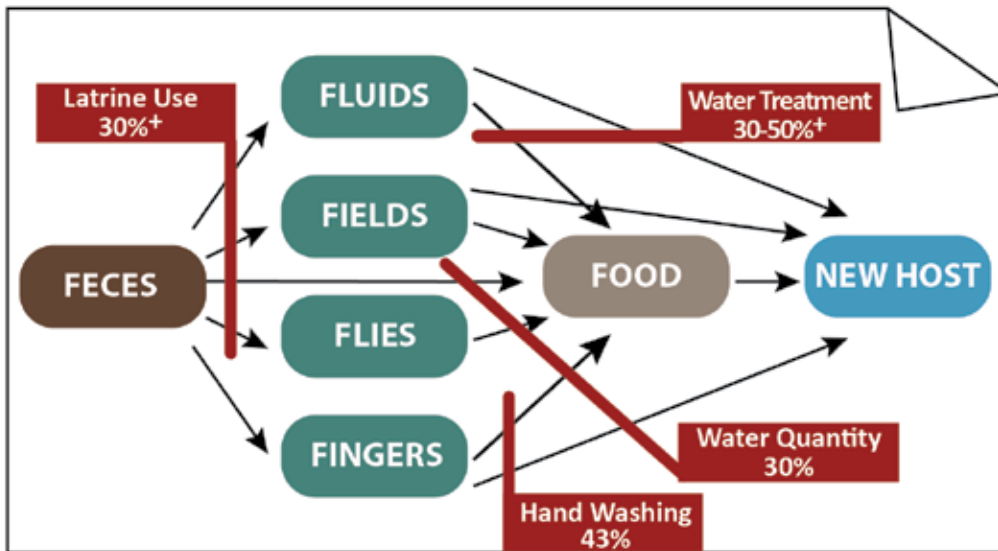

Source: Wagner and Lanois, 1958

10. Ask participants to say what one or two important points or things that were learned from the session.

Possible answers:

- ♦ The first defense against open defecation is proper latrine use by every member of the family, hand washing with soap or ash, and proper water storage and treatment.
- ♦ A safe latrine keeps the excreta away from people, as long as it has a cover or some other kind of seal to prevent flies and people from coming into contact with the feces.
- ♦ Latrines have the added advantage of providing privacy when they have walls and a door or curtain. Women and girls in particular really appreciate the privacy that latrines provide.
- ♦ After using the latrine, a person should wash his/her hands to prevent feces from making him/her sick.
- ♦ Where there are no toilets, like in the fields, feces can be made safe by burial in the ground. Even a shallow covering of soil over the top of the excreta will prevent flies from walking on the feces. Where no other type of feces disposal system is available, burial is a clean and convenient way of disposal. For example, a person working in the fields can bury his/her feces with a hoe. This is sometimes called the “cat method.”

- ◆ Care needs to be taken to make sure that all feces, including the feces of infants and children, are disposed of in a latrine or buried. Infants' feces actually contain more contaminants than even adult feces.
11. Tell the group that we just saw how feces enters our environment and our bodies, and we touched on how to block this, how to put up a barrier so infants and adults don't ingest feces and get sick from diarrhoea; and how the barriers can reduce or eliminate diarrhoea or ingestion of feces. This is especially important for infant feeding and food preparation. In the following sessions we'll review each of these key practices one by one—hand washing, safe drinking water, and safe feces disposal.
12. Wrap up by emphasizing that these “barriers” are our tools or weapons for breaking the oral-fecal cycle.
- ◆ Handwashing with soap
 - ◆ Safe disposal of feces
 - ◆ Treatment and safe handling of household waste
 - ◆ Food hygiene

MODULE I SESSION PLANS

Session 4: WASH Behaviours

Session Learning Objectives

By the end of the session participants will be able to:

1. Define behaviour and behaviour change
2. List the four key behaviours that can block fecal-oral contamination
3. Identify factors that influence WASH behaviour change

Prep Work

Prepare and Bring Supplies

- ◆ Handout 3: Factors that Influence WASH Behaviours

Time

60 minutes

Trainer Steps: What Influences WASH Behaviour Change

A. Explaining Behaviour and Behaviour Change (10 Minutes)

1. Ask participants what is a behaviour?
2. Explain that behaviour can be defined many ways but for the purpose of this workshop we will define a behaviour as something that is an action, is observable, is specific, measurable, doable and has a direct link to a health outcome.

What is a Behaviour?

A behaviour is not something we think or feel. It is an **observable action**. This observable action must be **specific**. For instance, “washing your hands” would be a better defined behaviour if we said “washing your hands correctly every time you defecate”. It is more specific and also **measurable**. It is also important that the desired behaviour you are promoting is possible and not too hard for your target population to achieve. For instance, “always treat your water with a filter” might not be a **doable** behaviour for people who do not have access to filters.

3. Ask participants what is behaviour change?

What is a Behaviour Change?

Behaviour change is modifying a not-so-healthy behaviour into a healthy behaviour. A range of efforts is usually needed to change behaviours. Often, behaviour change is mentioned in the same breath with communication. But there are many tools for influencing health behaviours and many factors that affect what people do. We need to look at all factors and available tools to choose the right tool for the job.

4. For the purposes of this workshop, when we look at changing behaviours we will follow a four step process:
 - ♦ Review current and correct practices
 - ♦ Determine what factors influence the behaviour
 - ♦ Identify small doable actions to improve the behaviour
 - ♦ Negotiate changes in behaviour at the household

B. Four Tools to Block Fecal-Oral Contamination (10 Minutes)

1. Ask the group to review what behaviours can block fecal-oral contamination? Elicit responses from the group. Remind the group that it's the BARRIERS they just identified in the last session.
2. Explain that there are FOUR KEY Behaviours we will focus on to block fecal-oral contamination. Emphasize that this is the foundation of our work.



1. Correct handwashing with soap at key times
2. Using hygienic latrines
3. Treating, storing and drinking water safely
4. Practicing safe food hygiene

C. Factors that Influence Behaviour Change (40 Minutes)

1. Tell the group that we are going to take a break from WASH for a moment to look at what influences behaviour. We're going to think about a less serious behaviour. Let's think about DANCING!!! Let's pretend that I have dedicated my life to dance and promoting dance.
2. Tell the group that you want to find out about people's dance practices. You want to find out who dances a lot and who does not dance a lot. One way to understand what influences a behaviour is to compare the people who DO and DON'T DO a behaviour and look for differences. Ask participants who have danced in the past month to get up and stand together. Next, ask participants who don't dance often to get up and stand together.
3. Tell the participants we are going to try to figure out what makes people avoid

dancers. Look at the two groups of people. What makes the groups different? Brainstorm with the group and write their responses on the flipchart.

- ◆ Prompt the group by asking questions like: Does gender make a difference? How about religion, are dancers more likely from a certain religious group? Does age make a difference? Does having friends who dance a lot make a difference? Does having access to music make a difference? Do you need music? Does knowing the steps or dance moves make a difference?

4. Explain that by comparing doers and non-doers we can come up with a list of factors that influence the behaviour of dancing. We can apply this same concept to adopting health-related behaviours. It's not about identifying barriers, it's about identifying DIFFERENCES between people who do and don't do a behaviour.
5. Ask the group, based on the dance exercise we just did, what factors might influence behaviour change? Help them see how the answers they just gave fall into the list of "factors" influencing behaviors.
 - ◆ Knowledge
 - ◆ Attitudes
 - ◆ Perceived risk
 - ◆ Intentions
 - ◆ Perceived consequences
 - ◆ Access to products
 - ◆ Self-efficacy
 - ◆ Availability and quality of services
 - ◆ Perceived social norms
 - ◆ Policy
 - ◆ Skills
 - ◆ Culture & traditions
6. Tell the participants that as you can see, it takes more than information and promotion to change behaviour. Tell participants that the same factors also influence our FOUR KEY WASH Behaviours.
7. Tell participants of the need to first identify current behaviours, identify feasible desired behaviours, and what factors may influence your target population to do or not do the behaviour. People are much more likely to adopt a behaviour that is FUN, EASY and/or POPULAR.

Make Behaviours Fun, Easy, and Popular

FUN: Positive consequences from doing the behaviour over vs. not doing the behaviour or doing the current behaviour.

EASY: Have the needed equipment and skills on hand to do the behaviour.

POPULAR: People important to you think you should be doing the behaviour.

8. Pass out Handout 3: Factors that Influence WASH Behaviours and review it with the group. Ask if there are additional factors that should be on the list?
9. Explain that we will now look closely at hand washing to:
 - ◆ Review current and correct practices of handwashing
 - ◆ Determine what factors influence correct hand washing
 - ◆ Identify small doable actions for hand washing
 - ◆ Negotiate small doable actions with the household

MODULE I SESSION PLANS

Session 5: Hand Washing

Session Learning Objectives

By the end of the session participants will be able to:

1. Explain the reasons for hand washing and the critical times to practice it
2. Demonstrate the correct way to wash hands
3. Build a tippy tap from locally available materials
4. List the advantages of using a tippy tap

Prep Work

Prepare and Bring Supplies

- ◆ Turmeric powder, glitter, or chalk powder
- ◆ Basin, water, and soap
- ◆ Handout 4: How to Wash Hands Correctly (replication of job aid)
- ◆ Handout 5: Hand Washing Calculations
- ◆ Handout 6: Different Types of Tippy Taps (replication of job aid)
- ◆ Handout 7: Instructions for Making a Tilting Jerry Can Tippy Tap (replication of job aid)
- ◆ Materials for each group to make a tippy tap
 - Empty plastic 1/1.5 litre water bottles AND/OR gourds AND/OR five litre jerry can
 - Pen casings AND/OR papaya stems AND/OR straws (anything that is hollow)
 - Sharp knives AND/OR nails and candles AND/OR screw drivers

Time

150 minutes

Trainer Steps: Hand Washing

A. The Importance of Hand Washing (30 Minutes)



TRAINERS NOTE

- Start the session with an activity as participants enter the room to make them aware of how easily and quickly hands can spread germs.
- ◆ Dip the palms of your hands into a bowl filled with turmeric powder or glitter (or chalk powder, colored dyes etc.).
 - ◆ Shake hands with participants, reapplying the turmeric or glitter as necessary.
 - ◆ Ask participants to greet each other and shake hands, too.
 - ◆ Touch other surfaces in the classroom, leaving a trail of turmeric, glitter, powder, or chalk powder.

1. Ask the following questions
 - ♦ What has happened to our hands and our friends' hands as we shook them?
 - ♦ Where else do you see the turmeric/glitter?
 - ♦ If the powder were feces or disease germs, how fast do you think contamination can occur?
 - ♦ How about in a school where there are many people close together?

Possible answers might include:

- ♦ Person-to-person contact spreads germs or feces contamination
 - ♦ Feces and germs clinging to unclean hands can easily get on food and from food into mouths
 - ♦ The number of germs on hands soars after using the toilet
2. Tell the group to imagine you were about to sit down and enjoy a meal. Just before you started to eat, you noticed your hands were covered with turmeric/glitter (or chalk powder, etc.). The powder represents just a fraction of the germs from feces present on our hands. Imagine that we could see our hands covered with millions of feces germs. Would you want to eat food or feed an infant with those hands? Would you continue eating? What would you do?
 3. Ask what might happen if you eat food without washing hands that are covered with germs? What might happen if you prepared food with germ-covered hands?

Possible answer: You can fall ill from the germs in the feces on your hands and also make others ill!

 **WASHING HANDS BEFORE EATING IS IMPORTANT!!
YOUR HANDS CAN BE VERY DIRTY EVEN IF THEY LOOK CLEAN.**



BRIEF LECTURE

Correct hand washing makes a huge difference to a person's health and well-being. Hands are used for anal cleansing after defecation. No matter what material is used for anal cleansing, hands still get contaminated from the feces, even if the feces cannot be seen or smelled. Hands should also be washed when leaving the latrine and before handling any kind of food. Both hands should be washed with running water and a cleansing agent.

Soap is the most effective hand washing agent.

When soap is too expensive or is not available, these alternatives can be effective:

- ♦ Wood ash will also lift and rub off any dirt and smells. The slight irritation you feel when you wash your hands with ash shows the cleansing power of ash;

FACT BOX



Washing hands at critical times, with soap and with proper techniques, is the most important hygiene measure to be integrated into HIV, AIDS [...and Nutrition programmes!]. Studies show handwashing can reduce diarrhoea by as much as 62%. (Shahid 1996)

- ♦ Clean sand with water can be used for hand washing to help rub off dirt.

It is important that everyone always washes his or her hands after defecation and before handling food. However, most people do not wash their hands often enough, or only use water. Hand washing should be made as easy as possible by keeping the hand washing water and cleansing agent beside the latrine, and if possible, also outside the kitchen or food eating area.

Conclude that hand washing with soap or ash after defecation and before handling food or feeding an infant will improve everyone's health (refer to Fact box).

B. Current Hand Washing Practices (10 Minutes)

1. Let's think about ourselves. How many of you washed hands before lunch yesterday? (make a joke, I won't ask about the toilet!) How about before tea?
2. Ask the group what are the current hand washing practices in many homes and schools in Uganda? And what is common after defecation? How about after a baby poos? And after cleaning a child's bottom?

Possible answers:

- ♦ Hand washing without soap when soap is not available
- ♦ "Dip" hand washing from communal bowl
- ♦ No systematic hand washing after cleaning the potty, after defecation, or after changing a nappy
- ♦ No systematic hand washing before eating/cooking



DEMONSTRATION: CORRECT HAND WASHING

C. The Correct Way to Wash Hands (20 Minutes)

In this activity you will demonstrate the correct way to wash hands and then have the participants practice.

1. Prepare a basin, a container of water that you can pour, and soap.
2. Ask what is the correct way to wash hands? Collect a few ideas and say that we will watch a demonstration.
3. Ask for a volunteer who can demonstrate the correct way to wash hands properly. Pour water over the volunteer's hand, and use as much as is reasonably possible. Ask the volunteer to explain each step to the group.



TRAINERS NOTE

It is best to have one volunteer wash hands as a facilitator pours the water. Use as much water as you can without being too obvious. Participants are focused on the hand washing technique, not the water use. You DO NOT want to try to save water in this demonstration. This contrasts later with the savings from using the tippy tap. **Wastewater should be caught in the basin below and saved.**

4. Ask the participants whether there were any gaps? Were all spots on the hands washed and rinsed? How were hands dried? Talk about these gaps and how to correct them. Review the process of correct hand washing and give a chance to other participants to practice correct hand washing.
5. Emphasize the importance of the washing process. In the washing process the soap or ash lifts the dirt and germs, breaks up seen and unseen filth on the hands, and the water then whisks it all away when hands are rinsed. The water does not have to be clean water, but it must be flowing water. Rubbing hands together is important, too.
6. After the demonstration and practice, ask what the correct steps to hand washing are and write up the list on the chart. The list might look like this one below:

How to Wash Hands Correctly

1. To wash, wet hands with running water
2. Rub your hands and fingers well with the soap or ash at least three times
3. Clean between the fingers, under your fingernails, and up to your wrists to help control germs
4. It is the soap or ash combined with the scrubbing action that helps dislodge and remove germs
5. Rinse your hands well with running water (pour from a jug or tap)
6. Dry them in the air to avoid recontamination on a dirty cloth

7. Pass out Handout 4: How to Wash Hands Correctly to the participants. Mention that this handout is the same as one of the job aids they will use. This card will be used in their work to help negotiate correct handwashing with household members.

D. When to Wash Hands (40 minutes)

1. Think about what it means for a typical family to improve their handwashing practice and wash their hands correctly at all times. First, let's review together what we call the "critical times" for hand washing.

2. Ask what are the critical times we instruct people to wash hands with soap?

Possible answers:

- ◆ After using the toilet
- ◆ Before eating or feeding a child
- ◆ Before breast-feeding
- ◆ Before preparing food
- ◆ After cleaning a baby's nappy

3. Tell the group that now we're going to figure out how many times a day a family needs to wash their hands. I'm going to ask you to think of a family of six, and calculate how many times a day this means they would need to wash.



GROUP ACTIVITY: CALCULATING HOW MUCH WATER IS NEEDED

1. Break into groups of three to calculate how many times a day the family needs to wash their hands. Pass out Handout 5: Hand Washing Calculations.
2. Number the groups.
3. Mention that there are no correct answers. Just make assumptions and proceed. For instance, a family of six probably has one or two infants under two and a maybe a mother-in-law. You decide, make decisions on all the undetermined possibilities, and proceed. Below is an example of how a group might calculate the number of times hand washing is needed per day BUT don't share this. The groups should come up with their own calculations using the provided blank sheet.
4. They have 15 minutes for this task. Groups often estimate a range of 25-60 washes. The example is just to make a point, so do not be concerned with precise number.

	Number of times a day per person	Number of family members	Total number of times per day
After defecation	2	4 (babies and young children don't wash their own hands)	8
After cleaning a baby's bottom	5	1	5
Before preparing food/cooking	3	2 (mother and daughter)	6
Before eating	3	4	12
Before feeding	5	3 (one baby will be breast fed, the other is fed)	15
Other: Before taking medicine	2	1	2
Other: After wiping child's bottom	1	3	3
Other:			
		TOTAL	51

5. Ask the "highest" and the "lowest" group to explain the "assumptions" of how they got to their totals.



TRAINERS NOTE

Have groups call out their number. Write these numbers on a matrix (see example to the right). There is no "right" answer. Leave room on the flip chart to the right of your numbers for more calculations later. Groups often estimate 25-60 washes. The example is just to make a point, so do not be concerned with precise number.

Group	# of Hand Washes Per Day	Total Water Needed
1	51	
2	60	
3	35	
4	25	
5	45	

- Tell the group that we are now going to use the number we just calculated for the number of hand washes needed per day to calculate how much water it would take this family to wash their hands the number of times we have recommended. First let's measure how much water it takes for ONE proper wash. We will measure the amount of water in the basin from our earlier demonstration of the correct way to wash our hands.



TRAINERS NOTE

Collect the used water in a basin and measure it. You can use a pitcher or a litre water bottle and estimate the amount.

- Now let's write the number of litres it took to wash hands ONE time on the Handwashing Calculations handout. Next let's multiply this number by the number of washes a family must do per day that your group calculated.

Calculate Amount of Water Needed for a Family for Hand Washing

Estimated amount of water to wash hands CORRECTLY (in litres) _____

Number of washings needed per day _____

Multiply water needed per hand wash X number of washings per day _____

TOTAL AMOUNT OF WATER FOR A FAMILY TO WASH HANDS FOR ONE DAY _____

- Ask groups to call out how much water they calculated to be needed for hand washing per day. Write the amount for each group on the flip chart. See example to the right. Total number of litres will vary.

Group	# of Hand Washes Per Day	Total Water Needed
1	51	102
2	60	120
3	35	70
4	25	50
5	45	90

- Ask the group:
 - Does it seem possible for a family to wash their hands XX times per day?
 - What makes it difficult for people to wash their hands?
 - What could they do to make it easier?
 - What could you do, in your role, to help make it easier for people to wash their hands correctly at the critical times?
- Conclude that it is difficult for families to do the ideal behaviours. Each 20 litres means another trip to the water source. A family washing hands properly could mean keeping the girl child out of school, just to carry out this task of bringing water for hand washing!

E. Making a Tippy Tap for Hand Washing (30 Minutes)

1. Explain that it is difficult to do correct hand washing without running water.
2. Ask the group if they think most homes would be able to provide that amount of water just for hand washing? Explain that we will learn how to build a hand washing device—a tippy tap—to help wash hands at the critical times even when water is scarce or where there is no tap for running water. This is a simple technology to make handwashing easier.
3. Show a sample tippy tap. Demonstrate quickly how it works. Do not demonstrate a complete hand wash but rather describe the basic benefits and how it works. Say, look you have it handy; you open and close it like this; it works like a tap that why we call it a tippy tap; it's right here in front of you, so it helps you to remember to wash and then makes it easy to do.
4. Pass out Handout 6: Different Types of Tippy Taps and Handout 7: Instructions for Making a Tilting Jerry Can Tippy Tap. Let the group know that these are also two of the job aids. Talk through each picture of the different types of tippy taps. Ask the group if anyone has ever made or used a tippy before? How was it constructed?



GROUP ACTIVITY

1. Divide the participants into four or five subgroups and have each group make a model tippy tap. Encourage groups to be innovative.
2. Provide each group with materials to make a tippy tap:
 - ◆ An empty plastic 1 or 1.5 litre water bottle, a gourd, or a five litre jerry can.
 - ◆ A pen casing, a papaya stem, a straw - anything that is hollow
 - ◆ A sharp knife, a nail and candle, or a screw driver to make a hole in the vessel for the tube
3. Hand out the instruction sheet and/or explain carefully to the groups how to make a tippy tap, using the instruction sheet as your guide. You can also write up instructions on a flip chart.
4. Let each group make a different type of tippy tap. The facilitator should also make one for demonstration. This will allow the participants to see for themselves the different options that can easily be made using locally available materials. At the end of the activity, participants should visit each site to see the tippy taps.

F. The Benefits of a Tippy Tap (20 Minutes)

1. Select a volunteer to wash hands with the tippy tap they have constructed. Capture the water in the basin.
2. Measure the water needed.
3. Ask The groups to do a final calculation now of how much water their family would

NOW need to wash using the tippy tap. Remind them how to calculate the amount of water needed per day:

**Calculate Amount of Water Needed for a Family for Hand Washing
Using a Tippy Tap**

Estimated amount of water to wash hands CORRECTLY (in litres) _____
 Number of washings needed per day _____
 Multiply water needed per hand wash X number of washings per day _____
 TOTAL AMOUNT OF WATER FOR A FAMILY TO WASH HANDS FOR ONE DAY _____

4. Ask each group to shout out their answers and write them on the flip chart.
5. Ask the group the following questions and write down the groups responses on the flip chart:
 - ◆ Why might hand washing devices and stations could be useful at home?
 - ◆ Where could they be located? (near latrines, near food preparation area)
 - ◆ Is one enough? (probably not —you can make 2 or more and hang them from poles or stand them on a platform)
 - ◆ What about soap availability at home? What ideas do you have to make sure enough soap is always available?
 - ◆ What kind of behaviour change opportunities do hand washing and making tippy taps present? (correct and consistent hand washing)
6. Conclude by reminding the group of the advantages of tippy taps
 - ◆ Serve as a reminder to wash
 - ◆ Allow for handwashing with flowing water in the absence of running water
 - ◆ Allow for “proper wash” with much less water, 1/10-1/4 litre vs. 1/2 to 1 litre
 - ◆ Allow for the flow of water to be regulated, to minimize the amount of water required to wash hands thoroughly
 - ◆ Remind that soap is “at hand” whenever handwashing takes place
 - ◆ A convenient and fun way to wash
7. Wrap up by asking participants to think back to our exercise on what influences behaviour. Ask what influences the behaviour of handwashing?

Possible answers:

- ◆ Specific knowledge: when and how to wash. Knowledge is necessary but not sufficient or enough to change behaviours.
- ◆ Skills to wash hands correctly.
- ◆ Access to soap.
- ◆ Access to water. A tippy tap can help create access.
- ◆ Is it a social norm to wash?
- ◆ Social norms: people important to you think you should wash your hands after using the latrine, before preparing food, and before feeding and eating.

MODULE I SESSION PLANS

Session 6: Improving WASH Behaviours through Small Doable Actions

Session Learning Objectives

By the end of the session participants will be able to:

1. Explain the concept of small doable actions
2. Formulate a few potential small doable actions from an “ideal” behaviour
3. Assess a household’s WASH behaviours and negotiate a small doable action to improve the family’s health

Prep Work

Prepare and Bring Supplies

- ♦ Handout 8: Guiding Principles for Negotiating Multiple WASH Needs
- ♦ Introduction and Instructions from Job Aid Pack (pages 2 & 3 in the job aid pack)

Time

120 minutes

Trainer Steps: Small Doable Actions

A. Introducing the Concept of Small Doable Actions (30 Minutes)

1. Explain the concept of small doable actions as “...progressively moving up to better practices...behaviours that a household can adopt without or with minimum added resources...” i.e. an interim step or small doable action from not washing hands with soap after visiting the toilet, to washing hands correctly with *ash* after visiting the toilet.

When it is not possible to do the “ideal” behaviour, then:

- ♦ Small doable actions are the small steps (‘baby steps’) or tasks that get closer to the desired or ideal WASH behaviour.
- ♦ Small doable actions still improve the health of the individual or household (even if those actions are not as great an improvement as the “ideal behaviour”).
- ♦ Small doable actions are considered feasible (possible, realistic) by household members, from THEIR point of view, considering their current practice, available resources, and particular social context.
- ♦ Although small doable actions fall short of an “ideal practice,” they are more likely to be adopted by a broader number of households because they are considered feasible within the local context.

2. Further explain that the small doable action approach involves:
 - ◆ **FIRST:** Assessing current household wash practices
 - ◆ **SECOND:** Identifying existing good WASH practices to be reinforced or modified
 - ◆ **THIRD:** Identifying feasible incremental steps that move people from a current practice toward the ideal practice
 - ◆ **FOURTH:** Identifying practices to be improved and negotiated with family member(s)



GROUP ACTIVITY

1. Divide into small groups, and have each group brainstorm some small doable actions for handwashing.
2. After ten minutes, discuss the small groups answers with the larger group.

Possible answers:

- ◆ Use tippy tap to conserve water
- ◆ Create hand washing station next to cooking station and next to latrine
- ◆ When soap is not available, use ash for hand washing—rub hands together, rinse, and air dry

B. Negotiating Small Doable Actions (45 Minutes)

1. Introduce the concept of negotiating improved practice.

Negotiating Improved Practice

The home visitor, counselor, family member or clinician must assess the barriers and facilitators to each WASH practice. THEN try to negotiate a commitment to try a few practices that seem feasible and worth changing, from the point of view of the householder, not someone else's assessment of what is important.

2. Pass out Handout 8: Guiding Principles for Negotiating Multiple WASH Needs. Go through the principles one by one and explain any unclear terms.

**Handout****Guiding Principles for Negotiating Multiple WASH Needs****Step 1: Prepare for a negotiation session**

- ◆ Review the content of the cards and bring them to the households you visit, or have them present at the clinical session.
- ◆ For each WASH behaviour, familiarize yourself with the small doable actions to assess and negotiate.

Step 2: Conduct an effective negotiation session

- ◆ **Make a good contact with the client and any household members in attendance**
 - Greet the client and household members.
 - Introduce yourself and explain objectives of your visit.
 - Ask to talk/discuss with household head about WASH practices.
- ◆ **Assess the household's current WASH practices**
 - Guided by the assessment card, ask questions and observe current WASH practices.
 - In the clinical session, the practices may "come up" in conversation or intake.
- ◆ **Identify the WASH practices already implemented and congratulate the client and household members**
 - Compare the household's current WASH practices with the SDA on the assessment card and identify what the client and household members are already implementing.
 - Congratulate the client and household member for implementing the SDA.
 - Encourage the client and household members to continue to implement the SDA.
- ◆ **Decide the WASH behaviour to be improved**
 - If the household or client has multiple WASH behaviours that need improvement, select on behaviour to start. Select the WASH behaviour to be improved based on the following criteria:
 - » Availability of materials/commodity/product at the household level
 - » Ease of implementation
 - » Importance/impact of practicing or not practicing the WASH behaviour
 - » Approval of the client

**GROUP ACTIVITY**

1. Break into groups of three. From the list below assign each group with two of the small doable actions for hand washing to negotiate in a role play.
 - ◆ Wash both YOUR hands and BABY hands before feeding your fifteen month old
 - ◆ Wash your hands before each meal
 - ◆ Use a tippy tap to conserve water
 - ◆ Create a hand washing station next to latrine
 - ◆ Create a hand washing station next to the cooking area
 - ◆ Keep soap, ash or cleansing agent next to the tippy tap
 - ◆ Wash your hands after cleaning your baby's bottom
 - ◆ Wash your hands after using the latrine
2. One participant will act as a counselor with a family who is trying to negotiate small doable actions for hand washing. The other two participants will act as family members.
3. The counselor should remember to implement the guiding principles for negotiating

WASH needs. Remember to only negotiate one small doable at a time.

4. Practice the role play. Each small group should take turns being the counselor. Between each role play, have team members give the “counselor” feedback about what was done well and what might be improved, with suggestions of how to improve the negotiation.
5. Bring the group back together after everyone has had a turn. Ask the group how the negotiations went. Was it easy to negotiate? Was it hard? Why? How is “negotiating” different from their current hygiene promotion approach or practice?



TRAINERS NOTE

If you end up with more than three people in each group, do not take the time to have everyone play every role. Conduct a maximum of three role plays.

C. Qualities and Skills of a Good Communicator (20 Minutes)

1. Explain that communicating well and establishing a good relationship with a household member is a crucial part of inspiring households to adopt small doable actions.
2. If communication with the household member is effective, it can significantly affect how households accept new and improved behaviours. It also increases the likelihood that the household will try to adopt the new/improved behaviour and enjoy the positive outcomes.
3. Ask: What are the qualities of a good communicator? Possible answers in box below:



TRAINERS NOTE

Below is a list of qualities of a good communicator:

- ♦ Able to keep confidentiality;
- ♦ Sensitive about when to speak and when to listen;
- ♦ Friendly and kind;
- ♦ A good listener and easy to talk to;
- ♦ Honest, responsible, and trustworthy;
- ♦ Patient;
- ♦ Helpful with problem-solving;
- ♦ Respectful of the client, family, and home;
- ♦ Empathetic — understands the client’s point of view and has the client’s interests at heart;
- ♦ Sensitive to customs and culture, gender relations, age, and body language;
- ♦ Not judgemental.

4. Remind the participants that we should help clients to think about their behaviours and decide to improve/change them on their own. Many individuals and communities have effectively modified or abandoned harmful hygiene practices once they were inspired and motivated NOT when they were confronted or instructed. Your job is to have them leave the session feeling committed and equipped to make the change.

D. Listening and Body Language Skills (25 Minutes)

1. Before starting, “model” or act out how body language “speaks” loudly without words. Act annoyed and frustrated with your participants. Cross your arms, sigh, squish up your face. Then ask participants how they think you are feeling
2. Tell participants that 80-90% of what you communicate is non-verbal. What you say with your body, attitude, and tone is more important than your words!
3. Ask the group how body language can show: Empathy? Respect? Kindness?
4. Explain that listening is an essential non-verbal form of communication. Ask participants to tell what it means to be a good listener. After one minute of brainstorming, ensure that at least the following have been mentioned:
 - ◆ Listening means to pay close attention to someone; to hear with intention. Good listening involves listening ACTIVELY.
 - ◆ A good listener does not interrupt, allows silences, and does not speak until he/she has listened.
 - ◆ A good listener lets the other person see she/he is listening by nodding, maintaining eye contact (if culturally appropriate), and asking questions at appropriate intervals.
5. Ask participants to give examples of what it means to have good body language that demonstrates you are actively listening to the client.

Signs of Active Listening	
Signs That You are Listening	Signs That you are NOT Listening
Facing the client	Looking away or around the room
Looking at the client when they speak	Being distracted
Nodding	Not acknowledging what is being said
Smiling or frowning appropriately	Fidgeting
Being calm	Flipping through papers
Being patient	Not allowing silent pauses
Maintaining eye contact	Interrupting
Asking questions	Not asking questions

6. After eliciting responses and writing them on the flip chart, pose these scenarios to the group:
 - ◆ What would you do if there was only one chair in the house you were visiting? (Answer - Sit on the floor or get something like a box to sit on.)
 - ◆ What would you do if the person you were visiting was in bed? (Answer – Ask permission to sit on the bed, or sit on a box or stool so you would be eye level with the client.)
 - ◆ What would you do if the client was washing dishes? (Answer – Sit on the ground next to the client. Maybe even ask if you can help while you talk.)

MODULE I SESSION PLANS

Session 7: Keeping Drinking Water Safe from Source to Mouth

Session Learning Objectives

By the end of the session participants will be able to:

1. Identify the links in the Water Safety Chain
2. Describe how to keep water safe at each “link”, from source to mouth

Prep Work

Prepare and Bring Supplies

- ◆ Handout 9: Water Safety Chain
- ◆ Handout 10: Taking Care of Drinking and Cooking Water (replication of job aid)
- ◆ Handout 11: Cleaning Drinking Water Storage Containers (replication of job aid)

Time

60 minutes

Trainer Steps: Keeping Drinking Water Safe from Source to Mouth

A. The Links in the Water Safety Chain (30 Minutes)

1. Explain that we have learned about the problem of defecating in the open, how to block the “F” routes, and have looked extensively at one of four key practices, hand washing. Now we will learn another way to break the fecal-oral cycle, which is another way to block feces from entering our food and water. We will learn about keeping water safe from source to mouth, and how we can ensure that our homes have safe drinking water for the whole household.
2. Ask for volunteers to answer the following questions (these are current practices):
 - ◆ Where they get their water (what **source or supply**)
 - ◆ How they **transport** water from the source to their home
 - ◆ How they **store** drinking water at home
 - ◆ How they **serve** drinking water at home – where they store it to their mouth



TRAINERS NOTE

If participants all have running water, ask them to also think about the communities they serve.

3. Explain that these are links in what we call the Water Safety Chain (see diagram to the right), and each part needs to be protected from feces contamination to make it safe. It is called the Water Safety Chain because if hygiene breaks down at any one link in the chain, the water is no longer safe for drinking.



4. Pass out Handout 9: Water Safety Chain. And as a group label the key links (supply, transport, storage, serving) on the handout.

B. Ensuring Water Remains Safe to Drink (30 Minutes)

1. Ask the group the following questions and make sure the key points from the chart and box below are discussed. Pass out and review Handouts 10 and 11 as key actions are discussed like, how to wash containers, how to keep water safe etc.
 - ♦ How can dirt and feces enter the water at the different points in the water chain and contaminate it? These are some of the factors that influence safe water behaviours.
 - ♦ What can you do at each point in the water chain that will prevent feces from making the water “bad” or unsafe to drink? These are small doable actions.
 - ♦ Make a chart on a flip chart capturing potential ways in each “link” that water could be contaminated, and then a few small doable actions to make it less risky, in other words to better protect the water (refer to chart below).

Steps in the Water Safety Chain	Small Doable Actions to Keep Water Safe
Supply of Water	Protect the source: If a well or standpipe <ul style="list-style-type: none"> • Build a fence so animals cannot defecate nearby • Build a raised platform and/or a soak pit • Wash hands with soap before collecting water • Do not put hand into container when collecting If an open source or stream: <ul style="list-style-type: none"> • Assure no animals or humans defecate upstream
Transporting Water	<ul style="list-style-type: none"> • Use a narrow neck container • Cover container • Attach cover to jerry can with a string so it doesn't get lost/stolen. Punch small hole in center of top. Thread with string and knot. Tie other end of string to neck of container, short enough so top doesn't touch the ground • Make a top with a clean potato or other object that can be washed • Do not stick hand into container when carrying

Storing Water	<ul style="list-style-type: none"> • Maintain water in narrow neck, covered container • Raise container off floor
Serving Water	<p>If no spigot on container:</p> <ul style="list-style-type: none"> • Pour water for use • Make a simple dipper/ladle for serving from calabash or can and stick. Hang on wall • Use mug with a handle to serve. Do not have hand touch water. Store in dedicated, clean place

Key Points for Discussion

- 1. Source of water:** Some water sources such as rivers, unprotected springs, or wells are already contaminated or have the potential to be contaminated. If a river is the only source, water should be collected upstream from any washing or bathing of people or animals. A well or spring should be fenced to keep animals away. The collection bucket and rope should be kept off the ground.
- 2. Water fetching containers:** Water can also be contaminated if water containers such as clay jars, jerry cans, etc. are not cleaned properly. Ask how often and what methods people use to clean their containers. Explain that proper washing includes filling the container about 1/4 full with water and soap or a little bleach, swishing it around the container, letting it sit for at least 20 minutes, rinsing until no soap or bleach is left, and finally drying the container in the sun. No cloth, rag, or hand should ever enter inside the jerry can. For open containers like buckets, wash hands with soap FIRST and then hands can be used when cleaning wide mouth containers.
- 3. Safe transport to the home:** Even if it is fetched from a safe and protected source, water can also be contaminated during transport. Be certain to cover all containers properly using clean covers or screw caps. A covered jerry can is the best. Open buckets are easy to contaminate and should be replaced by covered containers. Caps can be secured to the jerry can by using a 35 cm or so string. Tie one end around the jerry can neck and secure the other end to the lid by punching a hole through the inside of the lid, threading the string through the hole and tying it off with a knot
- 4. Storing water at home:** Water can also be contaminated at home when it is left open where animals can drink it and children can dip their hands in it. The safe way is to store it in a narrow necked container that can be covered with a screw cap or a hard cover. A clean jerry can is also a safe storage container.
- 5. Serving water at home:** Use a clean dipper or ladle that is hung on a nail when not in use.
- 6. Drinking vessel:** Use your own clean cup. If you share your cup, you'll share your germs!

MODULE I SESSION PLANS

Session 8: Action Planning

Session Learning Objectives

By the end of the session participants will be able to:

1. Identify their own small doable actions to support households and communities adapt good WASH behaviour
2. Develop an action plan to promote small doable actions in households and communities

Prep Work

Prepare and Bring Supplies

- ♦ Handout 12: Action Planning Template
- ♦ Handout 13: Small Doable Actions for WASH

Time

90 minutes

Trainer Steps: Action Planning

A. Small Doable Actions to Promote WASH (10 Minutes)

1. Remind participants that their role (whether they are VHTs, CKWs, Drama groups, etc) as a health care worker or community based resource person is to reach out to households to promote small doable actions for WASH. BUT we can also adopt our own small doable actions to promote WASH and integrate it into our nutrition activities.
2. Ask participants to brainstorm small doable actions they can adopt to integrate WASH into their nutrition activities with households and communities.
Possible answers:
 - ♦ “Model” behaviours by handwashing before teaching others how to hand wash.
 - ♦ Teach how to make a tippy tap at group sessions, especially in waiting rooms or places people wait a long time with little to do.
 - ♦ Add a brief module to an existing training.
3. Write answers on the flip chart for reference.

B. Action Plan to Promote the Identified Small Doable Actions (80 Minutes)

1. Divide the participants into their sub county groups and give them the task of

developing an action plan to integrate WASH into their nutrition activities. This will be a list of our own small doable actions.

2. Explain that they will use the planning format provided in Handout 12: Action Planning Template. Pass out the handout. If there are several different “actors” in one group, plan for all “result areas”.
3. Carefully go through each column of the template to explain what information is required.

Action Planning Template

Key Result Area for Change	Proposed Small Doable Action	Time Frame	Indicators	Responsible Person

4. Pass out Handout 13: Small Doable Actions for WASH to assist in developing action plans.
5. Give the groups 45 minutes to plan. Walk around to ensure groups are understanding and moving ahead with planning.
6. Have each group present their plan in just 5 minutes.
7. Review the completed action plans with the participants to ensure they are consistent with the objectives of this training and if an “official” WASHplus training, of USAID’s FHI 360/WASHplus project.
8. Remind participants that these plans should be integrated into their existing sub county nutrition interventions. Emphasize that follow up is important to ensure success.
9. Tell groups that you will “follow up” with them to see how their plans are progressing.

MODULE I EVALUATION

Prep Work

Prepare and Bring Supplies

- ♦ Handout: Workshop Evaluation

Time

10 minutes

1. Ask the participants to fill in the evaluation form provided. The workshop evaluation form is located at the end of the Module I Handouts.
2. Remind the group that no names should be put on the form.
3. Evaluation questions:
 - ♦ One (or two) ideas, skills, tools that you think will really be useful in your work.
 - ♦ One thing that wasn't clear or needed to be strengthened
 - ♦ One thing you would eliminate from the training
 - ♦ One word to summarize your overall experience during this training

TRAINERS NOTE



Collect the completed evaluation forms of the participants responses. Where possible, give feedback immediately or at a later convenient time by grouping all responses to each question. Include this analysis in your training workshop report.

Module I

Handouts

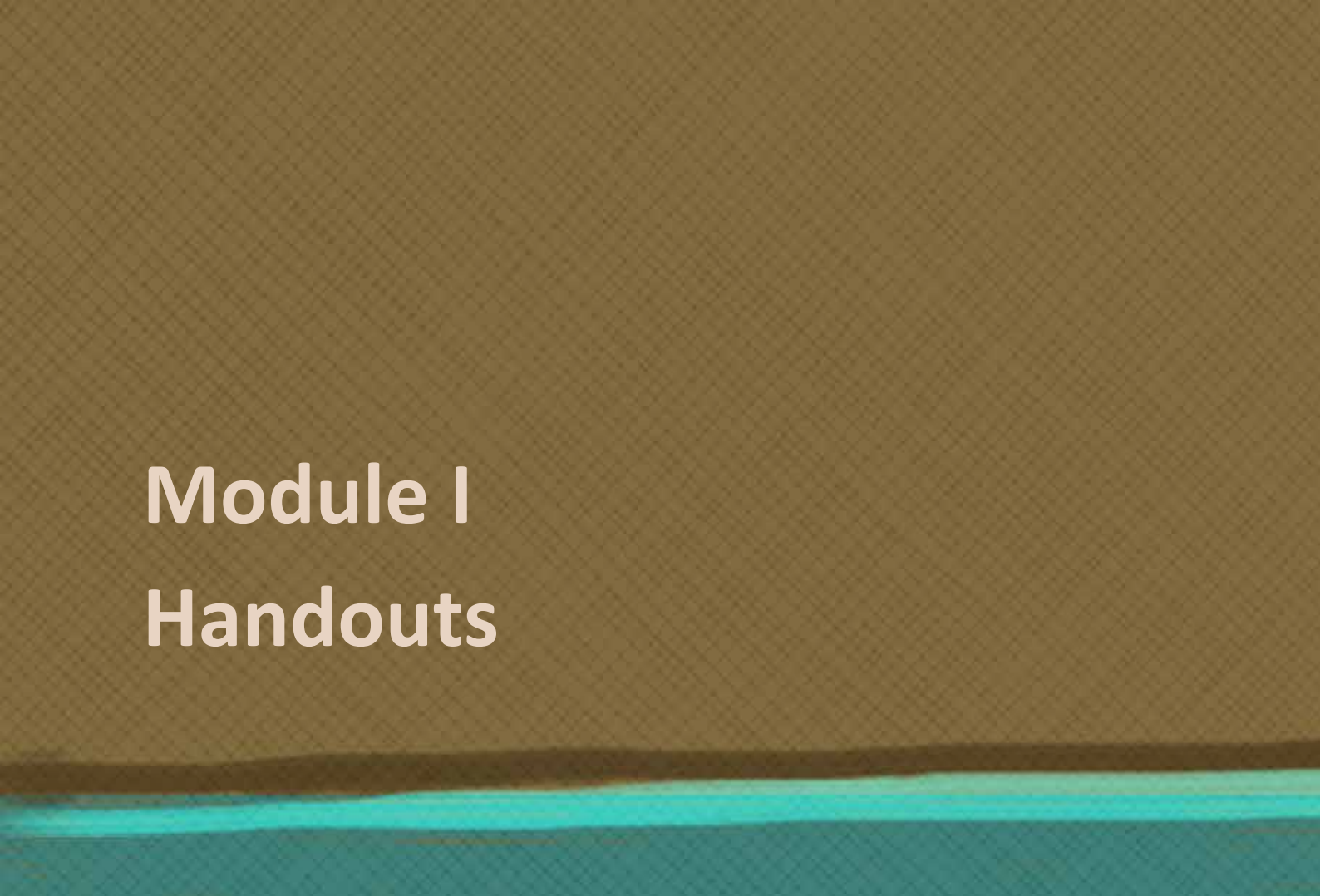



WHY WASH MATTERS FOR IMPROVED CHILD AND INFANT NUTRITION

DAY 1		DAY 2	
9:00-9:30	Session 1: Introduction to the Training	8:30-9:00	Recap of Day 1
9:30-10:30	Session 2: Why WASH Matters in Child and Infant Nutrition	9:00-9:30	Session 5: Hand washing (cont.)
10:30-11:00	Tea Break	10:30-11:00	Tea Break
11:00-12:30	Session 3: Blocking Fecal Contamination	11:00-1:00	Session 6: Improving WASH Behaviours through Small Doable Actions
12:30-1:30	Session 4: WASH Behaviours	1:00-2:00	Lunch Break
1:30-2:30	Lunch Break	2:00-2:40	Session 7: Keeping Drinking Water Safe from Source to Mouth
2:30-4:30	Session 5: Hand Washing	2:40-4:00	Session 8: Action Planning
4:30-4:45	Tea Break	4:00-4:15	Tea Break
4:45-5:00	Close	4:15-4:45	Close & Evaluation

Mr. and Mrs. Kanyesigye, uneducated farmers living in Nshemeire Village, had two daughters, five and two years old. They have not started going to school and they spend most of their time playing in the field and backyard with many other children in the village. Some of these children have colds with badly runny noses, some have diarrhoea, some pass roundworms whenever they defecate, some have skin problems (scabies). All these children play, pollute their environment, and pass illnesses from one to the other every day. It is not uncommon for children in the village to fall ill and die.

In this farm community, children are left behind while parents and other family members go to the farm every day for the whole day. The children eat leftovers—anything they can find in their own or their friends' houses. They never wash their hands before eating, but the elders don't either. Leftovers are normally left uncovered so flies, chickens, animals, and insects can get at the food. The water supply for this community is a pond where surface runoff is stored during the rainy season. Children sometimes go down to the pond to play and they also drink the water.

Eventually Kiconco, the two year old daughter of Mr. and Mrs. Kanyesigye, started getting sick and never got better. The mother asked her elder daughter if Kiconco had eaten anything at neighbors' houses. No, the elder sister said, she ate only the leftover food from what we had last night. Has she vomited or had any unusual thing, asked the mother. Elder sister replied that she vomited only once in the afternoon, but she complained of stomach pains and had frequent diarrhoea.

In the morning, Mrs. Kanyesigye saw that Kiconco was ill with a fever and stomach cramps. She told her husband that they had to take her to a health center or a health post. They left almost immediately but by the time they reached the health center Kiconco was very ill. Mrs. Kanyesigye, while looking at her ill daughter, started to cry. She was scared they would lose her from this world.



HANDOUT 3 ♦ FACTORS THAT INFLUENCE WASH BEHAVIOURS

Key Practice	What Influences Improved Behaviour
Use improved latrines	<ul style="list-style-type: none"> ◆ Available school latrines ◆ Available household latrines ◆ Available tools to bury feces if no latrines ◆ Perception of harm from NOT using latrines ◆ Motivation (disgust, nurture, status) to build latrine or acquire tools to bury feces ◆ Approval of peers/family members
Drink safe water	<ul style="list-style-type: none"> ◆ Available Water ◆ Access to treatment products ◆ Access to storage containers and lids ◆ Access to cups ◆ Access to ladles and places to hang them ◆ Knowledge of how to treat water ◆ Motivation (disgust, nurture, status) to treat water ◆ Approval of peers/family members
Wash hands with soap/ash	<ul style="list-style-type: none"> ◆ Available soap ◆ Available ash ◆ Available water ◆ Available running water (tap or jugs) ◆ Available basin ◆ Knowledge of how and when to wash hands ◆ Motivation (disgust, nurture, norms) to wash hands ◆ Approval of peers/family members
Properly prepare and cook food	<ul style="list-style-type: none"> ◆ Available space for a dedicated food preparation area ◆ Available soap to wash the food preparation area daily ◆ Available storage and treatment products for water to wash fruits and vegetables ◆ Knowledge of safe food preparation and cooking practices ◆ Motivation (nurture, status etc.) to safely prepare and cook food ◆ Approval of peers/family members

Small Doable Actions: How to Wash Your Hands

- 1** Wet your hands and lather them with soap (or ash).



- 2** Rub your hands together and clean under your nails.



- 3** Rinse your hands with a stream of water.



- 4**



Shake excess water off your hands and air dry them.

HANDOUT 5 ♦ HANDWASHING CALCULATIONS

How much washing and how much water for a family to wash consistently and correctly?

	Number of times a day per person	Number of family members	Total number of times per day
After defecation	X		=
After cleaning a baby's bottom	X		=
Before preparing food/ cooking	X		=
Before eating	X		=
Before feeding	X		=
Other	X		=
Other	X		=
		TOTAL	

Amount of Water Needed for a Family for Daily Hand Washing

Estimated amount of water to wash hands CORRECTLY (in litres) _____ (A)

Number of washings needed per day _____ (B)

Multiply water needed per hand wash (A) X number of washings per day (B)
= _____ (C)

TOTAL AMOUNT OF WATER FOR A FAMILY TO WASH HANDS FOR ONE DAY

HANDOUT 6 ♦ DIFFERENT TYPES OF TIPPY TAPS

1 Mineral water bottle - 1

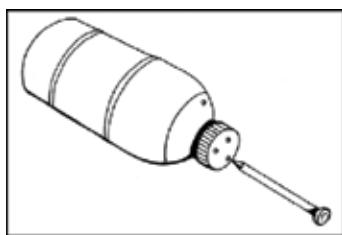

Punch a few holes on the mineral water bottle lid and one on the bottle to allow in air.

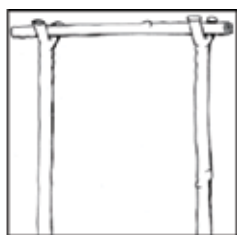

Fix poles.

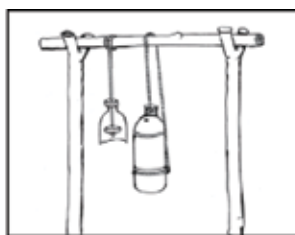

Hang bottle and washing soap on the fixed poles. Pour water in the bottle.



Use your elbow to tip the bottle facing down to allow water to flow.

2 Mineral water bottle - 2



Make a hole at the bottom of the mineral water bottle.

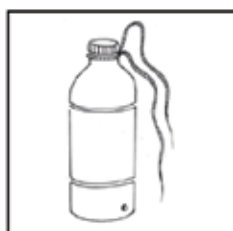

Fix string for hanging at the neck of the bottle.

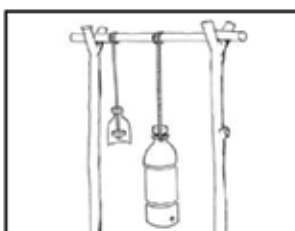

Hang bottle and washing soap on the fixed poles. Pour water in the bottle.

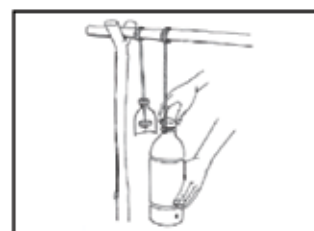

Loosen lid to allow water flow and tighten lid to stop water flow.

3 Tin can or leaky tin

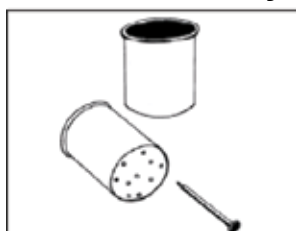

Take an empty tin, turn it over and make around 10 holes.

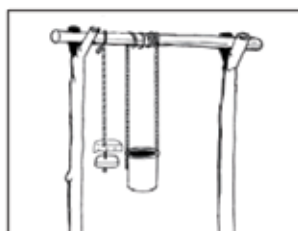

Hang soap and the tin on the wooden poles.



Pour a cup of water in the tin.



Wash hands with flowing water from the tin.

4 Hollow tube: on gourd or jerry can or mineral water bottle

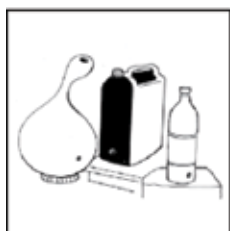

Make a hole toward the bottom of the container.



Insert hollow tube (pen, straw, casing, pawpaw stem) in the hole. A rubber band can be used as a gasket between straw and receptacle.

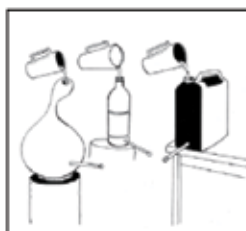

Fix plug in cover for the tube before you pour water in the container.



To start water flow, remove container lid or plug. To stop water flow, put tight the container lid.

Note: The tippy tap can hang from or be tied to a tree, pole or shelf. Ensure that a soak pit is put in place for the different hand washing facilities.

HANDOUT 7 ♦ INSTRUCTIONS FOR MAKING A TILTING JERRY CAN TIPPY TAP

Materials needed: A small jerry can with a lid (3-5 litres). 2 pieces of heavy string (60 cm) for hanging jerry can and (100 cm) for the pedestal. A thin string (60 cm) for hanging soap. Three poles, 1 suspension pole (80 cm), two standing poles preferably “Y” (150 cm). A mineral water bottle for soap protection.



Get a clean jerry can.



Using a nail, punch a hole on the lid for the pedestal string and at the jerry can handle for the dripping water.



Punch a hole for hanging string through the other side of the jerry can.

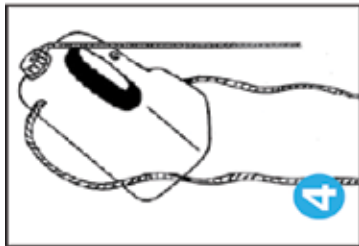

Place the hanging string through the nail holes and another string around the lid to attach to the pedestal.

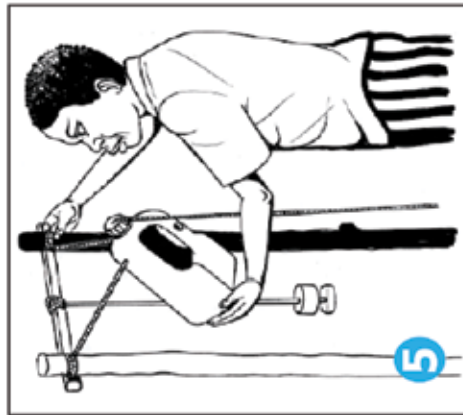

Hang the jerry can on two fixed poles. Make a hole in soap and cut the bottom off a mineral water bottle to use as a soap protector. Fix a string on them and hang on pole.

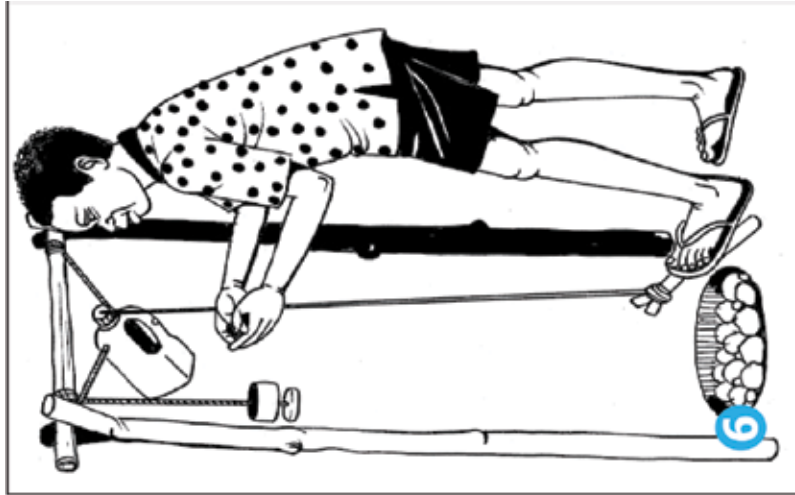

Tie solid stick to string attached to lid, long enough to reach about 10-13 cm from the ground. Step on the pedestal to tip water.

Put in place a soap pit by digging a shallow hole (60 cm wide and 30 cm deep)

HANDOUT 8 ♦ GUIDING PRINCIPLES FOR NEGOTIATING MULTIPLE WASH NEEDS

Step 1: Prepare for a negotiation session

- ♦ Review the content of the cards and bring them to the households you visit, or have them present at the clinical session.
- ♦ For each WASH behaviour, familiarize yourself with the small doable actions to assess and negotiate.

Step 2: Conduct an effective negotiation session

- ♦ **Make a good contact with the client and any household members in attendance**
 - Greet the client and household members.
 - Introduce yourself and explain objectives of your visit.
 - Ask to talk/discuss with household head about WASH practices.
- ♦ **Assess the household's current WASH practices**
 - Guided by the assessment card, ask questions and observe current WASH practices.
 - In the clinical session, the practices may “come up” in conversation or intake.
- ♦ **Identify the WASH practices already implemented and congratulate the client and household members**
 - Compare the household's current WASH practices with the SDA on the assessment card and identify what the client and household members are already implementing.
 - Congratulate the client and household member for implementing the SDA.
 - Encourage the client and household members to continue to implement the SDA.
- ♦ **Decide the WASH behaviour to be improved**
 - If the household or client has multiple WASH behaviours that need improvement, select one behaviour to start. Select the WASH behaviour to be improved based on the following criteria:
 - » Availability of materials/commodity/product at the household level
 - » Ease of implementation
 - » Importance/impact of practicing or not practicing the WASH behaviour
 - » Approval of the client

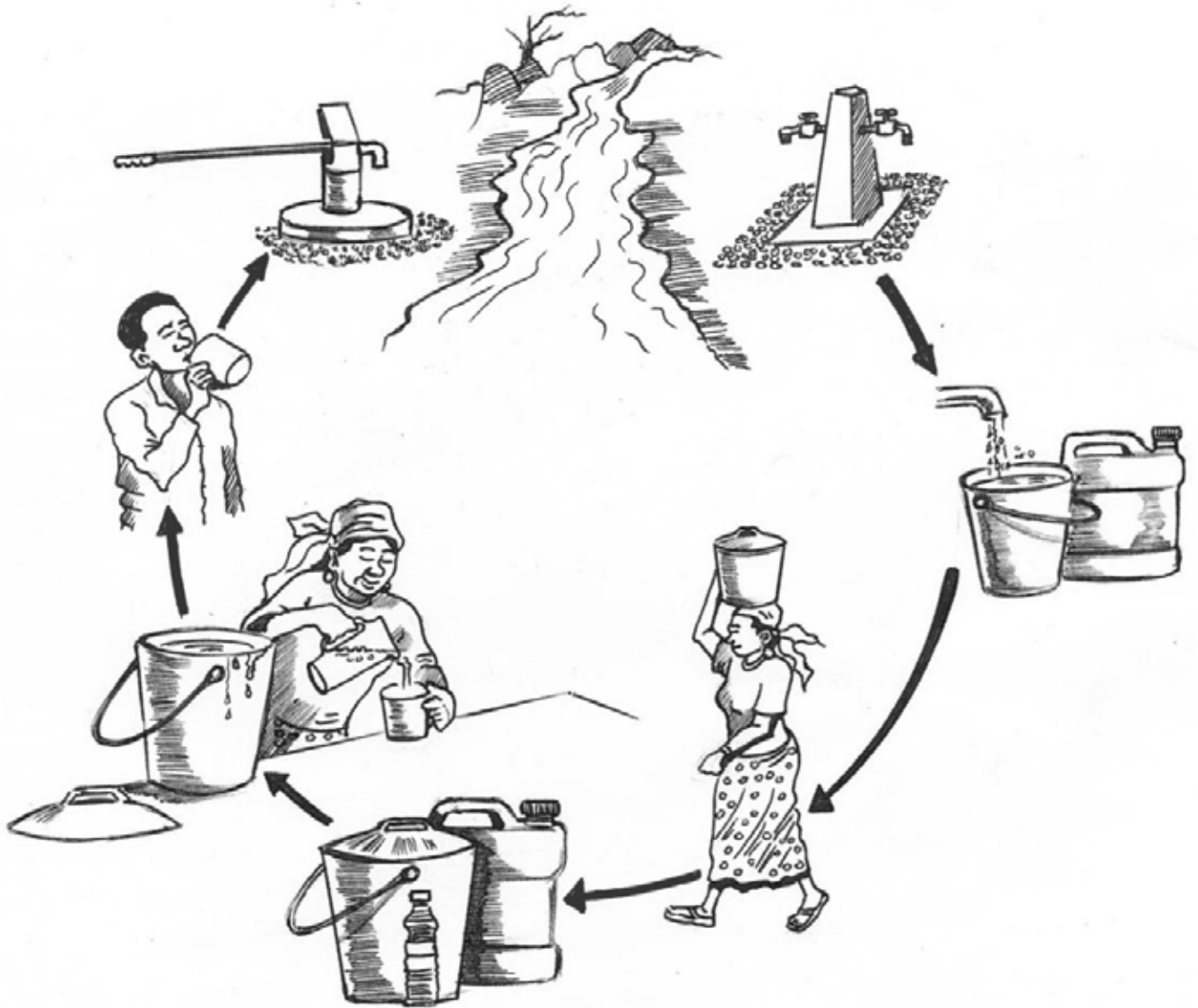

1 Transport

Carry your water home in a container with a lid



Small Doable Actions:

- Wash hands at source to avoid polluting new water
- Tie jerry can lid to container to avoid losing it
- Create a makeshift top with a clean potato washed each time at the source

2 Serving

Serve the water without letting anything dirty (such as your hands or a cup) touch it

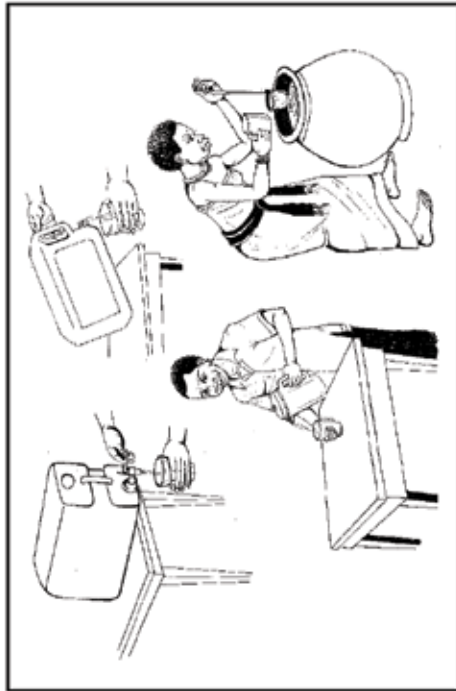

Small Doable Actions:

- Raise the container off the floor, ideally waist height for easier serving
- Buy or make a ladle for serving and hang ladle on a wall
- Have separate cups for serving and drinking

3 Storage

Store water in a container with a tight-fitting lid

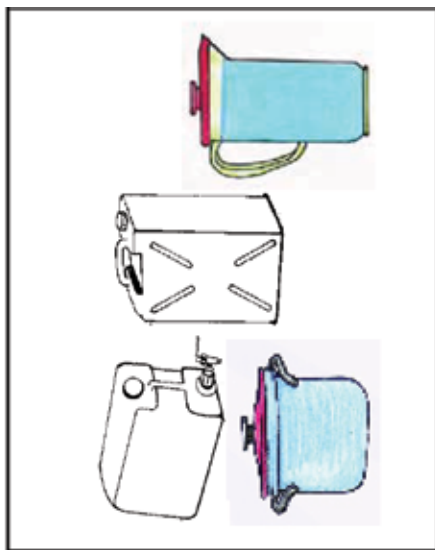

Small Doable Actions:

- Store container off the floor, ideally waist height for easy serving, to prevent contact with children and animals

Small Doable Actions to Make Water Safer to Drink: Cleaning Drinking Water Storage Containers



Wash the containers using water, soap or ash.
Small stones, sand or steel wire must not be used because they scratch the container leaving breeding places for germs. Rugs, grass or any other materials should not be used to clean drinking water containers, they can add germs that lead to contamination.

Washing water containers:

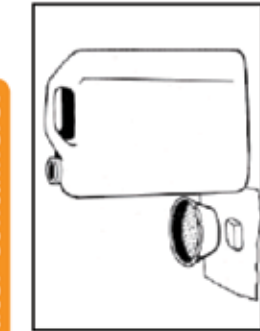

1. Put small amount of soapy water or ash in the container, shake the container and pour out the water. Small stones, sand or steel wire must not be used because they scratch the container leaving breeding places for germs. NEVER use a rag inside and NEVER insert your hand to clean.

2. Rinse the containers with water until there is no dirt, soapy water or ash.

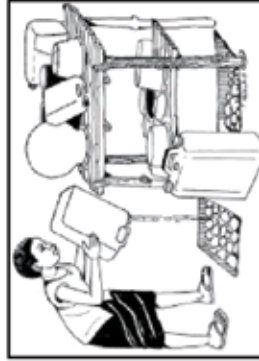

3. Use a rag to scrub the outside of the containers with soap and water. Thereafter rinse them again with clean water.

4. Finally hang the containers, preferably on a rack, to allow them to dry.

5. Cover the containers tightly and keep them away from dirt.

**There are 5 safe methods to make water better and safer for drinking:
WaterGuard | Aquatabs | Approved water filters | Boiling | Solar disinfection**

Key Result Area for Change	Proposed Small Doable Action	Time Frame	Indicators for Progress	Responsible Person

PROBLEM	SMALL DOABLE ACTIONS
Latrines and Feces Disposal	
<ul style="list-style-type: none"> ◆ No resources to build a latrine 	<ul style="list-style-type: none"> ◆ Devise small tool to be used for burying feces and store in convenient place ◆ Store tool in convenient place
<p>Latrine privacy</p> <ul style="list-style-type: none"> ◆ Has no door ◆ Straw wall has gaps ◆ Latrine doors are hanging/ broken hinges 	<ul style="list-style-type: none"> ◆ Hang a cloth as curtain ◆ Patch the door so it's solid, or replace with other temporary material like chitenge or other material ◆ Fix it! Often it will just take a few nails, screws, etc. for simple fixes
<ul style="list-style-type: none"> ◆ Latrine smells ◆ Flies in latrine 	<ul style="list-style-type: none"> ◆ Look for options to increase ventilation without losing privacy ◆ Cover pit with "home fashioned" lid ◆ Put bucket of ash in latrine and have users throw a handful in after every use ◆ Ash on hands is a good hand washing agent for after defecation
<ul style="list-style-type: none"> ◆ No separate latrines for girls ◆ No girl-friendly latrines 	<ul style="list-style-type: none"> ◆ Clearly dedicate at least half of latrines for girls ◆ Make signs "Girls Only" and "Boys Only" to mark ◆ Add a private washing station and a little mirror if possible
Hand Washing	
<ul style="list-style-type: none"> ◆ No fixed hand washing facility 	<ul style="list-style-type: none"> ◆ Hang tippy tap outside of latrine
<ul style="list-style-type: none"> ◆ No soap 	<ul style="list-style-type: none"> ◆ Use ash
<ul style="list-style-type: none"> ◆ No easy access to water 	<ul style="list-style-type: none"> ◆ Make a tippy tap to minimize amount of water used in hand washing
Water Safety & Storage	
<ul style="list-style-type: none"> ◆ Water stored in open container without lid 	<ul style="list-style-type: none"> ◆ Change to closed container with cap ◆ Tie lid to jerry can ◆ Devise a convenient cover for bucket or container (plastic bowl or clean potato)
<ul style="list-style-type: none"> ◆ Dirty cups used to get water out of storage container 	<ul style="list-style-type: none"> ◆ Make a dipper for extracting water from bucket or other receptacle ◆ Hang dipper off ground
<ul style="list-style-type: none"> ◆ Water from unprotected spring, shallow well, or other unsafe source 	<ul style="list-style-type: none"> ◆ Filter water to remove dirt and then treat water by boiling, solar disinfecting or chlorinating ◆ Build simple protection around spring
Food Safety & Storage	
<ul style="list-style-type: none"> ◆ No handwashing facility near cooking/eating area 	<ul style="list-style-type: none"> ◆ Hang tippy tap by cooking/eating area
<ul style="list-style-type: none"> ◆ Food stored in open containers ◆ Flies near stored food 	<ul style="list-style-type: none"> ◆ Devise simple covers for food storage
<ul style="list-style-type: none"> ◆ No dedicated food preparation area ◆ Food preparation area on the ground ◆ Food preparation area not washed daily 	<ul style="list-style-type: none"> ◆ Create small, raised separate space for food preparation ◆ Keep soap and water nearby to wash food preparation area daily
<ul style="list-style-type: none"> ◆ Raw foods not cleaned before consumption 	<ul style="list-style-type: none"> ◆ Ensure easy access to clean water to rinse fruits and vegetables eaten raw ◆ Create a reminder of daily cleaning at appropriate spot, i.e. put a reminder near dish rack

1. Write one (or two) ideas, skills, tools that you learned today that you think will really be useful in your work.
2. Describe one thing that wasn't clear or needs to be strengthened for future trainings.
3. Name one thing you would eliminate from the training that did not seem valuable, needed or "worth the time".
4. Give one word to summarize your overall experience during this training



Module II

Integrating WASH into Infant and Child Nutrition Programmes

Extended One-Day Training for Community Level Resource Persons

Module II

Overview

Target

Module II is day three of the training for community level resource persons, including VHTs, CKWs, PSGs, drama groups, and community volunteers. It includes practical training modules on “the other” key WASH behaviours, including keeping water safe and how to make it safer for drinking, and food hygiene – the direct link between food and nutrition.

Workshop Objectives

By the end of the module participants will be able to:

1. Demonstrate the different methods for making water safer for drinking
2. Explain how to improve WASH behaviours in relation to food hygiene
3. Appraise and improve WASH programmes through ongoing monitoring and evaluation

Training Materials

SESSION 1

- ♦ Handout 1: How to Boil and Store Water
- ♦ Handout 2: How to Practice Solar Disinfection
- ♦ Handout 3: PUR Instructions
- ♦ Handout 4: WaterGuard Liquid Instructions
- ♦ Handout 5: WaterGuard Tablet Instructions

SESSION 2

- ♦ Handout 6: Hazard Analysis Pictures

SESSION 3

- ♦ Handout 7: Self Reflection Tool

CLOSE

- ♦ Handout 8: Evaluation

Workshop Schedule at-a-Glance

DAY 3	
9:00-11:30	Session 1: Water Treatment Methods
11:30-12:00	Tea Break
12:00-1:30	Session 2: WASH and Food Hygiene
1:30-2:30	Lunch Break
2:30-3:30	Session 3: Improving WASH Programmes
3:30-3:45	Tea Break
3:45-4:30	Close & Evaluation

MODULE II SESSION PLANS

Session 1: Water Treatment Methods

Session Learning Objectives

By the end of the session participants will be able to:

1. Demonstrate the different methods for making water safe for drinking
2. Describe the advantages and disadvantages of each method

Prep Work

Prepare and Bring Supplies

- ◆ 2 half-litre plastic bottles of clean water
- ◆ Salt
- ◆ 1 bar of soap (or ash)
- ◆ 1 bowl/basin/katasa
- ◆ 1 jug/container of water for rinsing hands
- ◆ 1 bottle of WaterGuard chlorine solution
- ◆ 1 sachet of PUR chlorine product
- ◆ 1 WaterGuard tab (in its blister pack)
- ◆ 1 AquaSafe chlorine tablet (in its blister pack)
- ◆ 1 long-handled spoon or stirring sticks
- ◆ 2 pieces of tightly woven cloth (with no holes) to use as a filter over the container
- ◆ 1 clear bucket/container that holds 10 litres (for the PUR demonstration)
- ◆ 1 10-litre jerry can filled with water (for the PUR demonstration)
- ◆ 1 20-litre jerry can container (empty, if possible with a tap [like from PSI or Afford], container will receive the filtered water for the WaterGuard Liquid demonstration)
- ◆ 3 20-litre jerry cans container one filled with water (for the WaterGuard Liquid solution, WaterGuard Tab, and AquaSafe demonstrations).
- ◆ 30-plus disposable cups (for each participant to taste the treated water)
- ◆ Instructions: Prepare 2 small 1/2 litre bottles with drinkable water. Add salt to ONE of the bottles, half a spoonful at a time, shaking or stirring for it to dissolve. Add about 2 spoonfuls.
- ◆ A sample of very turbid water in a clear container (for PUR)
- ◆ A sample of very turbid water in a clear container that you decanted overnight if possible.
- ◆ Handout 1: How to Boil and Store Water
- ◆ Handout 2: How to Practice Solar Disinfection
- ◆ Handout 3: PUR Instructions
- ◆ Handout 4: WaterGuard Liquid Instructions
- ◆ Handout 5: WaterGuard Tablet Instructions

Time

150 minutes

Trainer Steps: Water Treatment Methods

A. Do We Need to Treat Water for Drinking if It Looks Clean? (15 Minutes)



DEMONSTRATION: SALTY WATER

1. Show the participants two ½ litre bottles of water (one bottle of water WITH SALT and the other bottle of water WITHOUT SALT) and ask them to look at them closely. Ask them if they see any difference in the water in the two bottles. Are they safe to drink?
2. Ask two volunteers to taste the sample of water WITHOUT salt. Assure participants that you won't do anything unsafe or that will make them sick, hurt nor embarrassed. They should both drink the water at the same time and be standing so that the other participants can see their faces when they taste the water. Repeat this process with the same volunteers using the water WITH salt.
3. Give the volunteers the opportunity to explain the difference between the two bottles of water.
4. Ask the observers what they learned from the volunteers' experience drinking the water. Reinforce the idea that although water appears clear and clean, it may have germs that can make a person ill.
5. Tell participants that we have just seen that it is possible for water to look perfectly clear and good to drink when it can actually have something in it that is very bad for you. This example just used table salt. But there are other invisible things that can make one very sick. It is therefore important to know what to do to "kill the germs" in water so that it is safe to drink, which is called "treating" your water.

B. Filtering (15 Minutes)



BRIEF LECTURE

1. In Uganda, there are three choices for water treatment: adding chemicals to it (chlorinating it), boiling it, or disinfecting it using the sun. But, as we know, many households in Uganda have water that is not clear, particularly during the rainy season. Instead, our water can be "chocolate" or very muddy or dirty-looking, which is sometimes called "turbid" water. So before treating the dirty-looking water, most people want to get the mud out first. We will now learn how to get the dirt out of your water before you treat it. When water is really turbid, the treatment methods don't work well, so in these cases it is essential to filter.
2. Review the two methods for filtering dirt out of water as described below:

Check for “Dirt” and Remove the “Dirt”

Fill a container with the untreated water. Determine if the water is clear enough or if it looks muddy or cloudy. If your water looks muddy or cloudy, then you need to remove the dirt by one of two methods.

1. Remove the ‘Dirt’ with a Cloth (Filtering):

- ◆ Pour the water through a clean piece of cloth (tightly woven with no holes in it) that is placed over the opening of a clean container. The dirt will get trapped by the cloth. After filtering your water, put the dirt that collected on the cloth where children and animals cannot get to it, such as in a latrine or buried in a hole. After dumping the dirt, wash the filter cloth and dry it in the sun.

2. Let the ‘Dirt’ Go to the Bottom and Pour Out the Clear Water (Settling and Decanting):

- ◆ Let the untreated water sit untouched for 12 hours so that the dirt settles to the bottom of the container while the clear water remains at the top of the container. Then pour (or decant) the clear water into a second, washed container while leaving the dirt behind in the original container. Throw away the dirt or residue remaining in the first container by rinsing the container and tossing the soiled residue where children and animals cannot get to it, such as in a latrine or buried hole.

3. Explain to participants that any tightly woven cloth can be used for this pretreatment step as long as it is clean, without holes, and big enough to cover the opening of the container into which the water is being poured.
4. Ask for a volunteer to help you demonstrate how to filter dirty water using the two methods described above.

C. Boiling (15 Minutes)

1. After you have filtered the dirt out of your water, the next step is to treat the water (or kill the germs in the water) by either boiling it, treating it by using the sun, or by adding some chemicals.
2. Tell them we will now review how to boil water. Ask the group:
 - ◆ How long do you boil water?
 - ◆ What type of fuel do you use to boil your water?
 - ◆ What type of container do you use to boil your water?
3. Make sure the main points are covered in your discussion on boiling water and the distribute Handout 1: How to Boil and Store Water.
 - ◆ Boiling is a way to make water safer for drinking.
 - ◆ Boiling is a method that can be used on clear and very turbid (muddy, cloudy) water. Most people prefer to remove the dirt before boiling to make the water

look and taste better in the end.

- ◆ **Water needs to be heated until LARGE BUBBLES appear**, not just the small bubbles on the side of the container.
- ◆ After the big rolling bubbles appear, you can stop boiling. There is no need to keep boiling for more minutes AFTER the big, rolling bubbles.
- ◆ Care must be taken not to recontaminate the water once it has been boiled.
- ◆ Cool the water while covered, which takes longer but keeps it safe.
- ◆ When cool enough, transfer to another clean and prepared container.
- ◆ The boiled water must be placed in a secure storage container, preferably with a lid and spigot to avoid recontamination. If the water is stored and served properly, it is safe to drink for 24 hours after it is treated. After 24 hours, the water is likely to be recontaminated and needs to be replaced with newly boiled water.
- ◆ Do not add “new” boiled water to “old” boiled water, meaning that you should completely empty your storage container of “old” boiled water before adding a batch of “new” boiled water. The “old” boiled water can be used for household work like washing clothes and dishes or for watering the plants or can be boiled again.

TRAINERS NOTE



Boiling water is a water treatment method that is known to be more widely available than chlorination. However, fuel may not be cheaply available, as it can have a substantial cost associated with it. It is important for participants, their clients, and their household members to choose the appropriate method of water treatment according to their household situation. The biggest consideration, is that boiled water can easily be recontaminated, often even before the treatment process is complete.

D. Solar Disinfection (15 Minutes)

1. Tell the group that the cheapest way to disinfect water is to use the sun. Ask if anyone knows how to treat drinking water using the solar disinfection (SODIS) method.
2. Ask the group:
 - ◆ What type of bottle should you use?
 - ◆ What steps do you follow?
 - ◆ How long does the water have to sit in the sun?
3. Make sure the main points are covered in your discussion on solar disinfection:
 - ◆ Use transparent plastic water or soda bottles that are 1-2 litres in size. Make sure the lid of the bottle closes and the bottle does not leak.
 - ◆ Clean the inside and outside of the bottles.
 - ◆ Fill the bottle 3/4 of the way with non-turbid water to be treated.
 - ◆ Shake the bottle for about 60 seconds.

- ◆ Now fill up the bottle completely and screw the cap back on.
 - ◆ Place the bottles on a flat surface and make sure they are exposed to the sky, unblocked. In bright sun, the water is “treated” in 6 hours. If there are 50% or more clouds, the water will need to sit exposed to the sky for two days to be treated, even if the sun wasn’t shining. Solar disinfection is NOT very effective in the rain.
4. Demonstrate how to treat water with SODIS. Pass out Handout 2: How to Practice Solar Disinfection.

E. Chlorine (45 Minutes)

1. DEMONSTRATION: HOW TO USE PUR

- ◆ Ask two volunteers to come to the front of the room to demonstrate the steps on how to use PUR sachets while you read the steps out loud. After the demonstration pass out Handout 3: PUR Instructions.

Steps for using PUR

- 1. Add Chlorine:** Fill a 10-litre container with untreated water that needs to be chlorinated. Open the PUR sachet and pour the powder into the water.
- 2. Stir:** Stir the water vigorously for five minutes. Stop stirring and let the water sit still for five minutes. At the end of the five minutes, the water should look clear and the particles or “dirt” should be at the bottom. Check and see if the water is clear. If the water is not clear, stir again until the dirt is separated from the water. The PUR powder causes the particles or “dirt” suspended in the water to clump together and then sink.
- 3. Remove the ‘Dirt’ with a Cloth (Filtering):** Remove the dirt that has settled on the bottom by filtering the water through a tightly woven cloth. Pour the water through a clean piece of cloth (tightly woven with no holes in it) that has been placed over the opening of another clean container. After filtering your water, put the “dirt” that collected on the cloth during the filtering step where children and animals cannot get to it, such as in a latrine or buried in a hole. After dumping the dirt, wash the filter cloth and dry it in the sun.
- 4. Wait and Drink:** Let the clear water sit for 20 minutes. After waiting for the water to sit for 20 minutes, the 10 litres of treated water is safe to drink.

TRAINERS NOTE



As part of the PUR demonstration a participant has to stir the water for five minutes and then let it stand for 20 minutes. During this time, have a second group of participants conduct the demonstration for how to use WaterGuard Liquid solution.

2. DEMONSTRATION: HOW TO USE WATERGUARD LIQUID

- ♦ Ask for two new volunteers to come to the front of the room to demonstrate the steps on how to use WaterGuard Liquid while you read them out loud. Following the demonstration distribute Handout 4: WaterGuard Liquid Instructions.

Steps for using WaterGuard Liquid

- 1. Filter Water through Cloth:** Fill a 20-litre container with untreated water that is filtered through a clean cloth.
- 2. Add Chlorine Solution:** Remove the cap from the WaterGuard bottle.
 - ♦ If your water was cloudy or muddy before you filtered it through a cloth (in Step 1), then pour TWO CAPFULS of WaterGuard Liquid into the 20-litre jerry can full of untreated water.
 - ♦ If your water was CLEAR before you filtered it through a cloth (in Step 1), then pour ONE CAPFUL of WaterGuard Liquid into a 20- litre jerry can full of untreated water.
- 3. Shake:** Cover the jerry can and shake thoroughly until the WaterGuard is completely mixed with the water in the jerry can.
- 4. Wait and Drink:** Let the water sit for 30 minutes. The water is now safe to drink. If mixed correctly, there should be little to no odor or taste. If it smells like chlorine, you are probably using too much so check the dosage. Do NOT under dose to save money because the treatment won't be effective.

Remember: After a week, be sure to discard any unused water treated with WaterGuard Liquid solution and use it for other household activities like washing dishes and clothes. Treated water lasts only up to a week if stored in a clean narrow necked container with a lid (and tap/spigot, preferably).

3. DEMONSTRATION: HOW TO USE WATERGUARD TABLETS

- ♦ Ask for two new volunteers to come to the front of the room to demonstrate the steps on how to use WaterGuard Tablets while you read them out loud. After the demonstration distribute Handout 5: WaterGuard Tablets Instructions.

Steps for using WaterGuard Tablets

- 1. Filter Water through Cloth:** Fill a 20-litre container with untreated water that is filtered through a clean cloth.
- 2. Add Chlorine Tablet(s):**
 - ♦ If your water was cloudy or muddy before you filtered it through a cloth (in Step 1), then open the WaterGuard Tablet package and put TWO chlorine tablets into the untreated water. Cover the container. There is no need to stir or shake the water.
 - ♦ If your water was CLEAR before you filtered it through a cloth (in Step 1), then open the WaterGuard Tablet package and put ONE chlorine tablet into the untreated water. Cover the container. There is no need to stir or shake the water.

3. Wait and Drink: Let the water sit for 30 minutes. The water is now safe to drink.

Remember: After a week, be sure to discard any unused water treated with WaterGuard Tablets and use it for other household activities like washing dishes and clothes. Treated water lasts only up to a week if stored in a clean narrow necked container with a lid (and tap/spigot, preferably).

4. DEMONSTRATION: HOW TO AQUASAFE TABLETS

- ♦ Ask for two new volunteers to come to the front of the room to demonstrate the steps on how to use AquaSafe Tablets while you read them out loud.

Steps for using AquaSafe Tablets

- 1. Check for “Dirt” and Remove the “Dirt”:** Fill a 20-litre container with water that needs to be chlorinated. Determine if the water is clear or if it looks “dirty” (muddy, cloudy). If the water looks clear, skip the rest of this step and go directly to Step 3. If the water looks “dirty,” then go to Step 2 to filter the “dirt” from the water.
- 2. Filter the Water through Cloth:** Fill a 20-litre container with untreated water that is filtered through a clean cloth.
- 3. Add Chlorine Tablet(s):**
 - ♦ Add Two Tablets for River, Well, Dam or Dirty Water: If your water was collected from a river, well, dam, or from any source and it was “DIRTY” (and you had to get the “dirt” out first by filtering or settling and decanting), then open the AquaSafe blister package and put TWO chlorine tablets into the water. Cover the container.
 - ♦ Add One Tablet for Tap Water: If your water was collected from a tap and was CLEAR (so you did not need to get the “dirt” out first), then open the AquaSafe blister package and put ONE chlorine tablet into the water. Cover the container.
- 4. Wait and Drink:** Let the water sit for 30 minutes. The water is now safe to drink.

Remember: After a week, be sure to discard any unused water treated with AquaSafe Tablets and use it for other household activities like washing dishes and clothes. Treated water lasts only up to a week if stored in a clean narrow necked container with a lid (and tap/spigot, preferably).

5. Explain to participants that there are a few important points that should not be overlooked when you treat your water with chlorine. These include:
 - ♦ All water that has been treated by chlorination must be used or dumped from the container before a new batch of water is chlorinated and stored.

- ♦ Care must be taken not to recontaminate the water once the product has been added. Treated water must be placed in a secure storage container, preferably with a lid and spigot to avoid recontamination. If the water treated with chlorine is stored and served properly, it is safe to drink for up to a week after it is treated.
- ♦ One advantage of the chlorine products is that they keep re-disinfecting for at least 24 hours (if no additional water is added, which dilutes or weakens its ability to re-disinfect).
- ♦ It is very important to check the expiration date on the package and to NOT use the product after it has expired.
- ♦ The bottle WaterGuard Liquid solution is good for 30 days (one month) after it has been opened. After 30 days, an opened bottle of WaterGuard Liquid solution should be discarded.
- ♦ Water treated with chlorine can be kept and drunk for up to one week when it is stored in a narrow neck container with a tight fitting lid. If it is stored in a wide mouth container or without a lid, it can only be drunk for up to 24 hours.

F. Advantages and Disadvantages of the Different Methods (45 Minutes)



GROUP ACTIVITY

1. Divide Participants into four groups for a quick group exercise. Assign one method (boiling, solar disinfection, PUR, WaterGuard liquid, WaterGuard tablets, AquaSafe) to each group and ask them to take 10 minutes to write down what they know about the pros and cons of that method.
2. Ask each group to share what they wrote.
3. Prepare a flip chart before the session with basic pros and cons and show it to the group after they have shared their answers.
4. Discuss the advantages and disadvantages of each method.

Treatment Methods	Advantages	Disadvantages
Boiling	<ul style="list-style-type: none"> ♦ Every home and probably every school has a place to boil water ♦ It's cheap (if wood is cheap) ♦ It's effective—boiling kills everything 	<ul style="list-style-type: none"> ♦ Uses wood that may be scarce ♦ Water can get re-contaminated after boiling when it is poured into another storage container ♦ Not practical for a school ♦ Possibility for contamination ♦ Not ready for immediate drinking, must be cooled
Solar Disinfection	<ul style="list-style-type: none"> ♦ It's very cheap ♦ It's effective ♦ Easily Available 	<ul style="list-style-type: none"> ♦ Takes a long time to treat the water ♦ Takes even longer if it is not a sunny day

Chlorine	<ul style="list-style-type: none"> ◆ Very effective ◆ Leaves germ-killing residue in water ◆ A little goes a long way ◆ Easy to administer 	<ul style="list-style-type: none"> ◆ Product might be too costly for large communities ◆ Product might not be easily available ◆ Some methods take longer to treat than others
----------	--	---

5. Ask what treatment method seems most appropriate for households? Is it the same for every house in the district? Is one method more appropriate in different seasons of the year? What factors might influence a household decision to use one method or another? And for schools?
6. Why? Do you know of any households or schools currently treating their water?
7. What has their experience been?
8. Have the group come try the water that was filtered by the various chlorine methods. How does it taste?
9. Summarize the key points using the prepared flip chart page:
 - ◆ Even water that is safe at the well can become contaminated, and clear water is not always CLEAN water.
 - ◆ Water can become contaminated while carrying, storing, or retrieving it.
 - ◆ The best way to carry water is in a covered container.
 - ◆ The best way to store water is in a covered container with a spigot (tap).
 - ◆ The best way to retrieve water is to take it from the spigot or pour it out.
 - ◆ Never dip a bowl, cup, or your hands into the container with your treated water because you can easily re-contaminate it.
 - ◆ Always serve water in something clean.

MODULE II SESSION PLANS

Session 2: WASH and Food Hygiene

Session Learning Objectives

By the end of the session participants will be able to:

1. Explain why WASH matters in food preparation and consumption
2. Summarize food chain process and how contaminants can get into the process
3. Describe current practices that lead to food contamination
4. Identify small doable actions to improve WASH behaviours in relation to food hygiene

Prep Work

Prepare and Bring Supplies

- ♦ Handout 6: Hazard Analysis Pictures

Time

90 minutes

Trainer Steps: WASH and Food Hygiene

A. The Link between WASH and Safe Food (10 Minutes)

1. Ask the participants about the link between WASH and child/infant health (this was presented in day one of the training). The following points should be emphasized:

Poor WASH habits and behaviours lead to diarrhoea.

When a child or infant has diarrhoea, nutrients from food are not well-absorbed. Additionally, children with diarrhoea tend to eat less. These two factors can lead to under-nutrition.

Under-nutrition contributes to between 1/3 and 1/2 of all mortality worldwide.

Undernourished children are more susceptible to diarrhoea making them further undernourished or malnourished.

2. Ask the group, why do you think the problem of open defecation is especially serious for the community? Again, this is a review from the first day.

Answers might include:

- ◆ Feces can get into contact with our food and food containers and cause diarrhoea.

3. Ask the group to think of some things that can be done to help keep feces away from reaching our food to prevent diarrhoea.

Possible answers:

- ◆ Use latrines and toilets
- ◆ Wash hands with soap to remove dirt and feces, especially at important times such as after defecation
- ◆ Wash fruits before eating
- ◆ Keep (leftover) food covered
- ◆ Corral animals to avoid contact with food containers
- ◆ Protect our drinking water (filtering, boiling, or treating with chlorine solution)

B. Understanding the Food Chain (20 Minutes)

1. Explain that the food chain is the process of food production (growing/raising the food), distribution or preparation (making the food), and consumption (eating the food). Write Production, Distribution/Preparation, Consumption, and Storage on the flip chart.
2. Explain that we will take the example of eating a grilled chicken leg. The first step in the food chain is raising the chicken, which includes what we feed the chicken and how we keep the chicken healthy. This would be part of the production process of the chicken leg.
3. Partner with a person and brainstorm on the different steps of the “grilled chicken leg” food chain. Think in terms of the production phase, preparation phase, and the consumption phase.
4. Ask for pairs to share their steps.

C. How to Keep Food Safe (30 Minutes)

Grilled Chicken Leg Food Chain Example

1. Production	2. Preparation	3. Consumption	4. Storage
◆ Separating chickens from people	◆ Cleaning the chicken	◆ Placing chicken on a plate	◆ Covering food
◆ Handwashing before and after slaughter	◆ Cutting the chicken	◆ Eating chicken with hands (or utensils)	◆ Storing fresh and cooked food separately
◆ Cleaning surfaces after slaughter and disposal	◆ Grilling the chicken		◆ Storing food on a high shelf inside kitchen area or cupboard

1. Explain the phrases ‘hazard analysis’ and ‘critical control points’, as a systematic

preventative approach to food safety and hygiene, designed to prevent contamination and food-borne illness.

Hazard Analysis and Critical Control Points

‘Hazard analysis’ and ‘critical control points’ are about looking at every stage in the food chain process, whether it’s food production, preparation, and eliminating risk factors. By analyzing your processes and identifying the points where something could go wrong – one can prevent the kind of practices that lead to serious illness and even death.

2. Tell the participants that we will conduct a hazard analysis of the current food handling practices during the preparation and consumption phases of the food chain and potential sources of contamination at each stage that must be avoided, removed or reduced.
3. As a group, revisit the F-diagram. Together, identify how feces can enter into food we eat, making us sick.

F-Diagram: Possible Fecal-Oral Contamination Routes

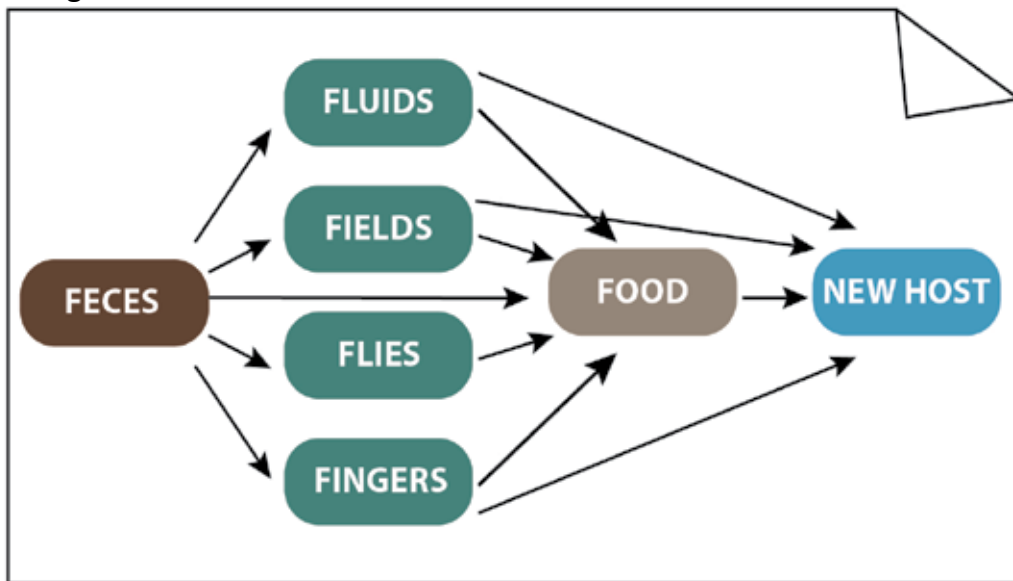

Source: Wagner and Lanois, 1958

4. Identify the points in your (household) food chain process where these hazards can and must be prevented, removed, or reduced.

Answers might include:

- ◆ During hand-washing before preparation of food,
- ◆ During separation of raw and cooked food during preparation
- ◆ During cleaning of food in preparation
- ◆ During cooking to high enough temperature
- ◆ During storage of food in separate and closed containers



GROUP ACTIVITY

1. Divide into 3-5 groups of 5 people each. Pass out Handout 6: Hazard Analyses Pictures to each group and ask them to identify the potential dangers of contamination in each of them.

Hazard Analysis Cards

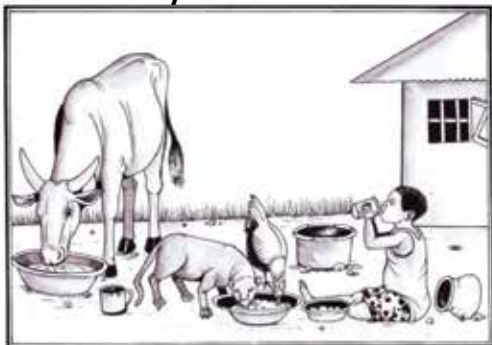

2. Review the small groups' answers in plenary. Organize answers by the different stages of the food chain: production, preparation & handling, serving, and storage.

D. Identifying Small Doable Actions to Promote Food Hygiene (30 Minutes)

1. In groups, tell participants we will be identifying small doable actions which are applicable to ensuring food hygiene at each stage of the food chain. Assign each group one stage of the food chain to identify and list small doable actions to reduce the dangers of contamination.
2. Review the groups' answers in the larger group.
 - ◆ Wash hands before preparing food
 - ◆ Wash raw foods with clean water before consuming
 - ◆ Prepare meat separate from other foods and use a designated meat knife
 - ◆ Serve food on clean bowls/plates
 - ◆ Wash hands before consuming food or feeding others
 - ◆ Store food in closed containers
3. Tell the participants that by identifying small doable actions at every food handling stage, you can prevent contamination of food.
4. Distribute the job aid on food preparation and handling, serving, and storage. Review and discuss this job aid.
5. Wrap up by reminding participants it is important to change behaviours around food safety, and that small doable actions are possible to move towards the ideal situation. The job aid is designed to help them negotiate small doable actions. There may be other small doable actions for particular household situations.



TRAINERS NOTE

Be certain that the participant's answers are small doable actions and not "messages".

MODULE II SESSION PLANS

Session 3: Improving WASH Programmes

Session Learning Objectives

By the end of the session participants will be able to:

1. Explain how to use documentation and monitoring to improve household WASH behaviours
2. Demonstrate how to use the self reflection tool to improve skills working with households

Prep Work

Prepare and Bring Supplies

- ♦ Handout 7: Self Reflection Tool

Time

60 minutes

Trainer Steps: Improving WASH Programmes

A. Documenting and Monitoring WASH Activities (30 Minutes)

1. Explain to participants that this next session will focus on information community resource persons should document about the WASH activities in households.
2. Ask participants why it is important to document and monitor what they do in WASH at various households. Record responses on the flip chart.

Possible Answers:

- ♦ To help clients and families improve WASH practices
 - ♦ To learn from personal success and failures
 - ♦ To improve programmes
 - ♦ To evaluate, i.e. - reduction in diarrhoea due to improved WASH practices at home
3. Explain that documenting the work we do provides a written record to store facts, events, activities, etc. We should document our work in a way that makes it accessible and usable by those who need it.
 4. Remind participants about the principles of good record keeping. Acknowledge record keeping can be difficult, but the following points should be kept in mind:
 - ♦ Date the information;
 - ♦ Record the information under the appropriate headings/sections;
 - ♦ Be consistent with the information;

- ◆ Collect information at the right time;
- ◆ Record complete information;
- ◆ Ensure that the written information is legible;

**TRAINERS NOTE**

Emphasise that there are always lessons to be learned from any activity, successful or not. It is important to record and understand these to avoid making the same mistakes again. Learning from such lessons is a part of good programme management. Remind participants that sharing lessons is not the same thing as sharing facts and details about clients and their care. Respecting client confidentiality is critical.

**SMALL GROUP ACTIVITY**

- ◆ Store confidential records in a secure place.
1. Ask participants to form small groups or pairs from the same organization. Ask them to discuss:
 - ◆ How they currently document and/or report what they do on a home visit.
 - ◆ How they can incorporate documentation of WASH activities within their specific organization or programme.
 - ◆ What information they should document from WASH activities.
 2. After the participants have discussed the above for 10 minutes, review their answers with the larger group.
 3. Explain for WASH activities it is useful to document:
 - ◆ WASH practice(s) that the client and/or family member agreed on to improve (i.e., the client agreed to try hand washing with soap after toilet use).
 - ◆ Document the changes made by the client and/or family member (which are noted when the information is gathered in a follow-up visit).
 4. Distribute the WASH Assessment Card. Review how it is designed with the group. Emphasize that each “row” represents ONE behaviour and include small doable actions from left to right, moving towards the ideal practice. Discuss how the assessment card might aid with monitoring WASH activities and improvements.

**TRAINERS NOTE**

Emphasize that this assessment tool is designed to help outreach workers remember small doable actions and keep track of a household’s progress. It is NOT a teaching aid.

B. Self Reflection to Improve Skills (30 Minutes)

1. Explain that to improve your skills and the services you provide, you need to get in the habit of asking yourself a few simple questions after you leave a client’s home.
2. Tell the participants they will now learn a self-reflection technique. Pass out Handout 7: Self Reflection Tool. Review the hand out together and answer any questions.

3. Ask participants to remember the role play they conducted yesterday to negotiate a small doable action with a family. Ask each person to fill in the self-reflection tool based on their performance in the role play. What did you do well? What can you do better?
4. Explain to the participants that it is important to use this checklist both as a self-reflection tool and to make sure they are appropriately assisting households with their WASH practices.
5. Thank everyone for a wonderful workshop. Remind them that they are critical to ensuring improved child nutrition and health in their communities.

MODULE II EVALUATION

1. Ask the participants to fill in the evaluation form provided. Let them know that it is the same form they filled in for days one and two of the training. They should only evaluate day three of the training with this form. The workshop evaluation form is located at the end of the Module I Handouts.
2. Remind the group that no names should be put on the form.
3. Evaluation questions:
 - ◆ One (or two) ideas, skills, tools that you think will really be useful in your work.
 - ◆ One thing that wasn't clear or needed to be strengthened
 - ◆ One thing you would eliminate from the training
 - ◆ One word to summarize your overall experience during this training



TRAINERS NOTE

Collect the completed evaluation forms and carry out analysis of the participants responses. Where possible, give feedback. Include this analysis in your training workshop report.

Module II

Handouts

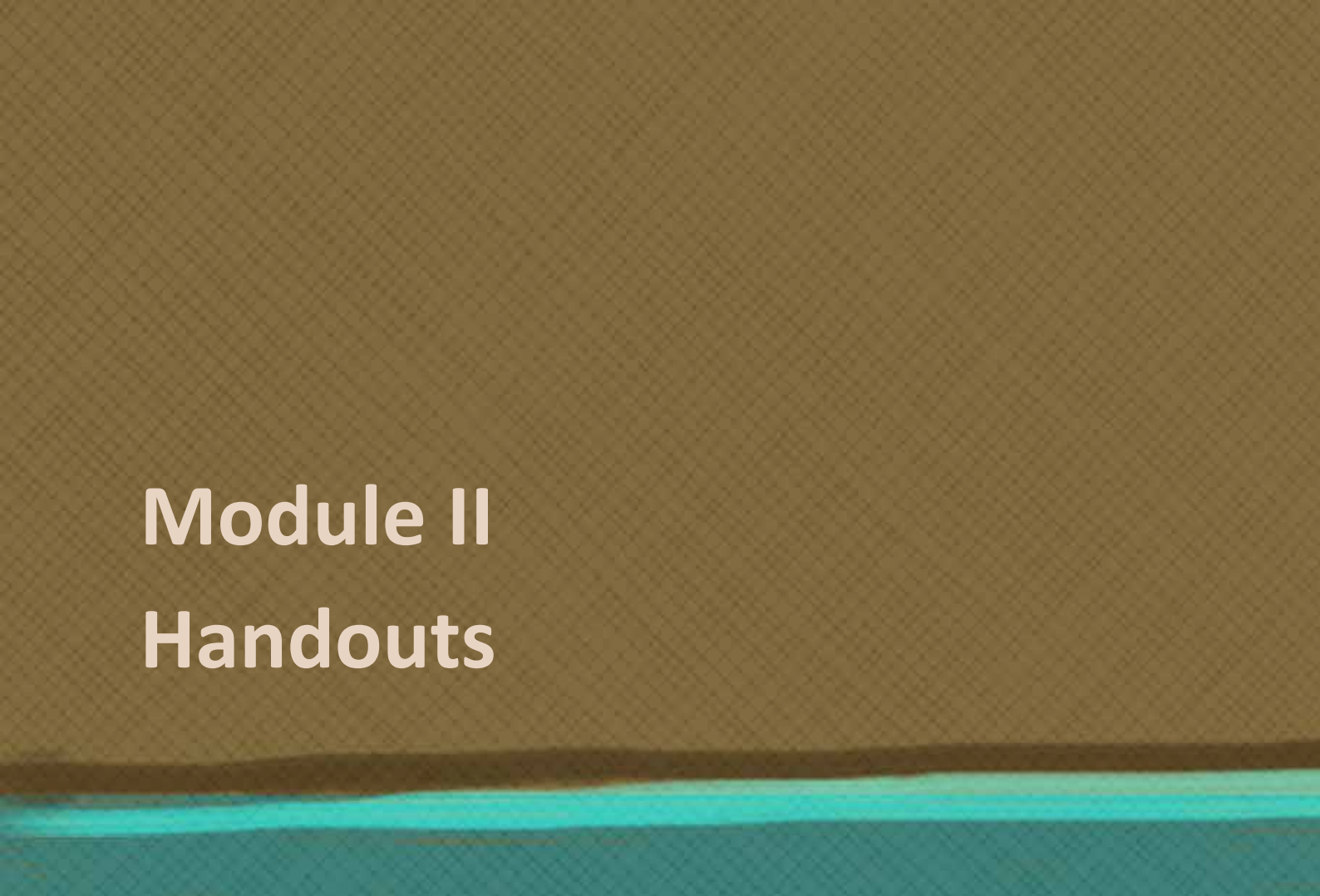



1 Collect water from water source

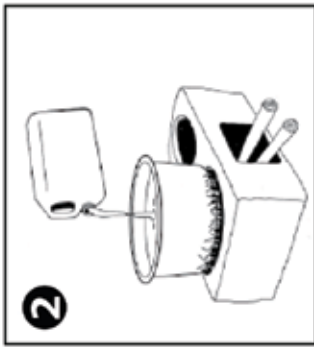

2 Pour water into boiling container.

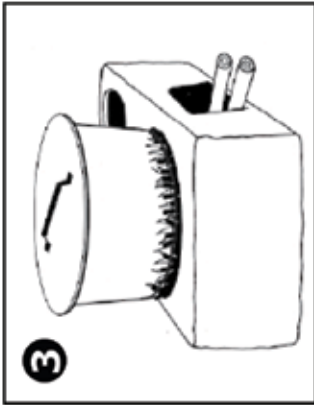

3 Cover water boiling container.

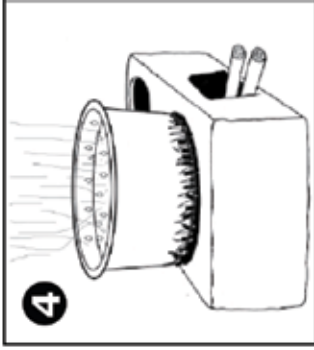

4 Boil the water until large bubbles appear.

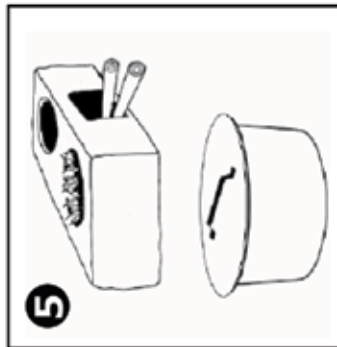

5 Remove from fire and allow to cool. Do not remove lid to avoid contamination.



6 Store boiled drinking water in containers with tight covers.



7 Do not use the serving cup for drinking.

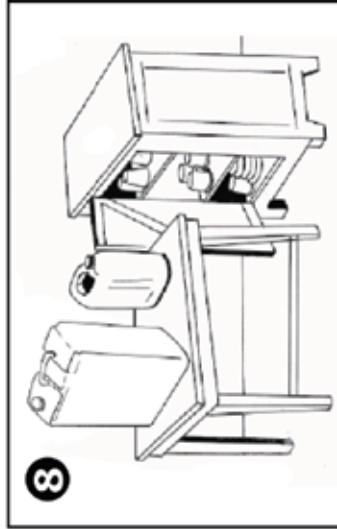

8 Store drinking water in tightly covered containers, in a clean environment on a stool or table and away from children and animals.

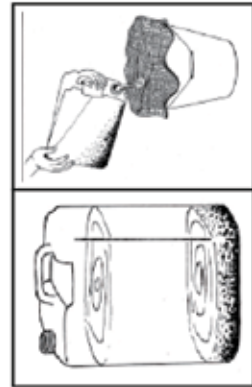

Filtering and boiling

If the water is dirty, leave it for some time so that the dirt settles below the container. Clean this water by filtering. To achieve good results do the following:

- Get a clean cloth and clean container such as a bucket and place the cloth on top of the container.
- Carefully pour the settled water through the cloth into the clean container. Make sure the settled residue or dirt does not pour out.
- After filtering ensure that you boil your water to kill germs.

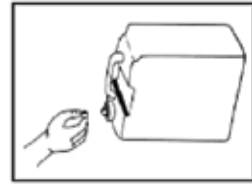

Treat drinking water

Drinking water can also be made safe by adding purifying tablets such as AquaSafe or WaterGuard. Follow instructions on the label of the water purifier.

HANDOUT 2 ♦ HOW TO PRACTICE SOLAR DISINFECTION

The only materials needed for SODIS are:

1. Clean transparent plastic bottles with their lids.

- The bottles should hold no more than 2.5 liters each.
- Use only transparent plastic mineral water or soda bottles. You should not use green, brown, blue, or other colored bottles or glass bottles (because the color and glass do not allow the sun's rays to disinfect the water).
- Fill the bottle half way with water.
- Shake for about one minute (to aerate water, putting more oxygen in the water).
- Fill the bottle to the top.
- Lay bottles of water down on their sides (rather than leave them standing).
- If your bottles are very opaque or scratched, discard them and use others.
- Remove the labels on the bottles because the labels block the sun's rays from disinfecting the water.

2. Clear Water

- You can only use the SODIS method with clear water.
- You cannot treat turbid (murky or dirty) water with the SODIS method. If the water is turbid, the chlorination method or the boiling method should be used.

Important notes:

1. After opening a bottle of water treated with SODIS, it should only be kept for 24 hours. After that, it should be discarded.
2. You should not drink water treated with SODIS directly from the bottle, putting your mouth on the bottle. To drink the water, pour some in a clean glass or cup.
3. You cannot use the SODIS method if it is raining all day long, because there is not enough sunlight to reach the water.

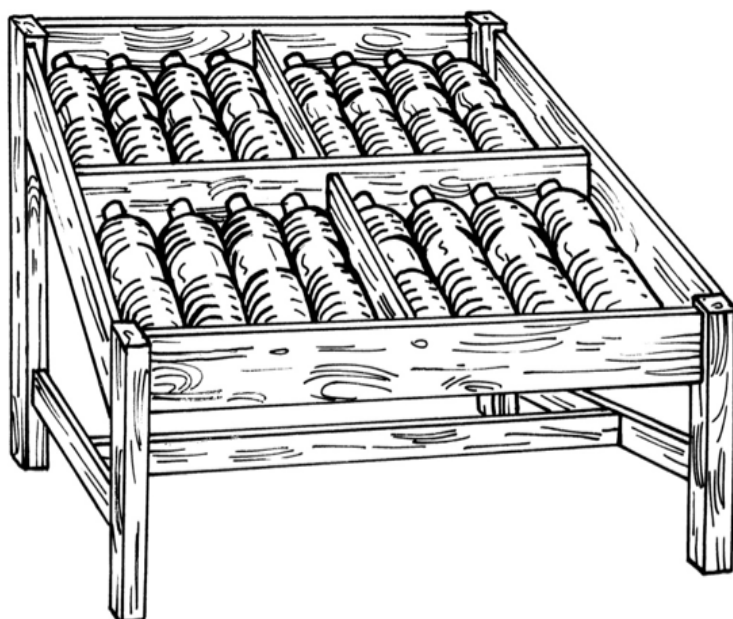

To the left is a solar disinfection (SODIS) stand with plastic PET bottles placed in the sun to make drinking water safe. After 6 hours in the sun, the water is safe to drink.



1. MIX

5 MINUTES **5 MINUTES**

Stir well.

Let water stand.

If water is not clear, stir again until the floc is separated.

3. FILTER

Use clean thick 100% cotton cloth without any holes.

Dispose of the filtered floc away from children and animals.



Wait for 20 minutes

4. DRINK

Do not drink if water is yellow in color.

Remember: Water treated with PUR that is stored in a narrow neck container with a tight fitting lid can be drunk for up to seven days. Treated water in a wide mouth container or without a tight fitting lid can be drunk for only 24 hours.

HANDOUT 4 ♦ WATERGUARD LIQUID INSTRUCTIONS

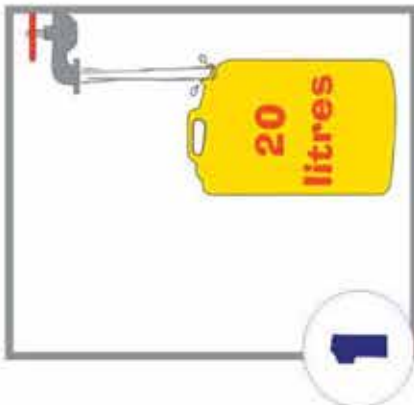

1

Filter a clean 20 litre jerry can with water filtered through a cloth.

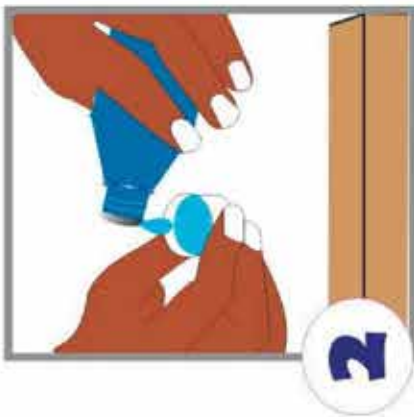

2

Fill the bottle cap with WaterGuard.



3

Pour the capful into the 20 litres of water.

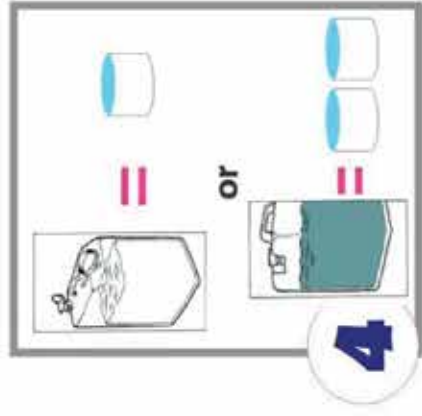

4

For clear water use 1 capful.
For dirty water use 2 capfuls.



5

Close the jerry can and shake.

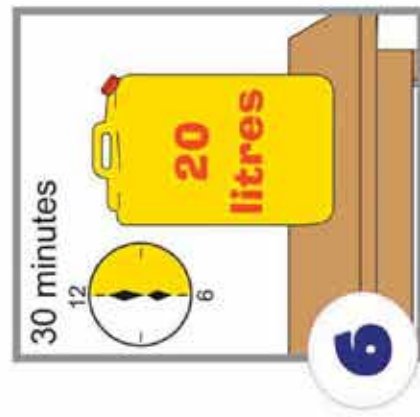

6

Wait 30 minutes before using.



7

The water is now ready to drink.



8

Store it away from children and sunlight.

Remember: Water treated with WaterGuard that is stored in a narrow neck container with a tight fitting lid can be drunk for up to seven days. Treated water in a wide mouth container or without a tight fitting lid can be drunk for only 24 hours.

HANDOUT 5 ♦ WATERGUARD TABLET INSTRUCTIONS



Does your water look clear?



1

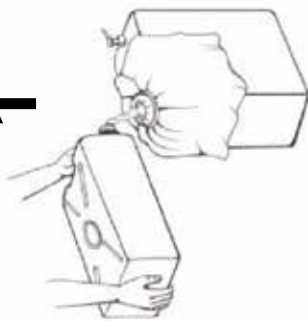

Filter the water through a clean cotton cloth.

2

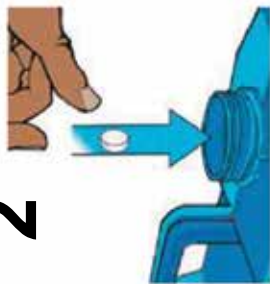

Add 1 tablet to 20 litres of filtered water.

3



Wait 30 minutes.



4

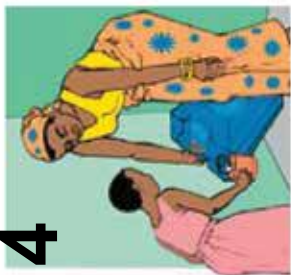

Water is now ready to drink.

Does your water look dirty?

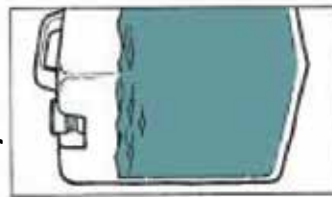

1

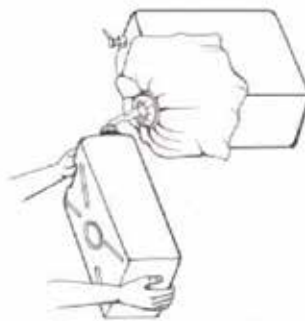

Filter the water through a clean cotton cloth.

2

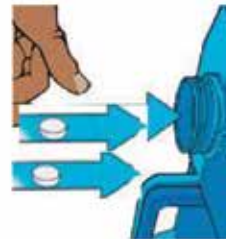

Add 2 tablet to 20 litres of filtered water.

3



Wait 30 minutes.



4

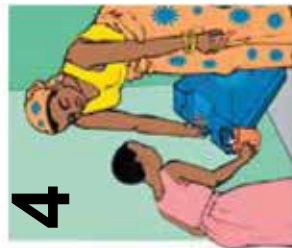

Water is now ready to drink.

Remember: Do not swallow tablets and store them away from children and sunlight. Water treated with WaterGuard that is stored in a narrow neck container with a tight fitting lid can be drunk for up to seven days. Treated water in a wide mouth container or without a tight fitting lid can be drunk for only 24 hours.

Adapted from WaterGuard Tab and AquaSafe instructions originally compiled with Population Services International, Centers for Disease Control, and Mendentech Ltd., Co. Wexford, Ireland.

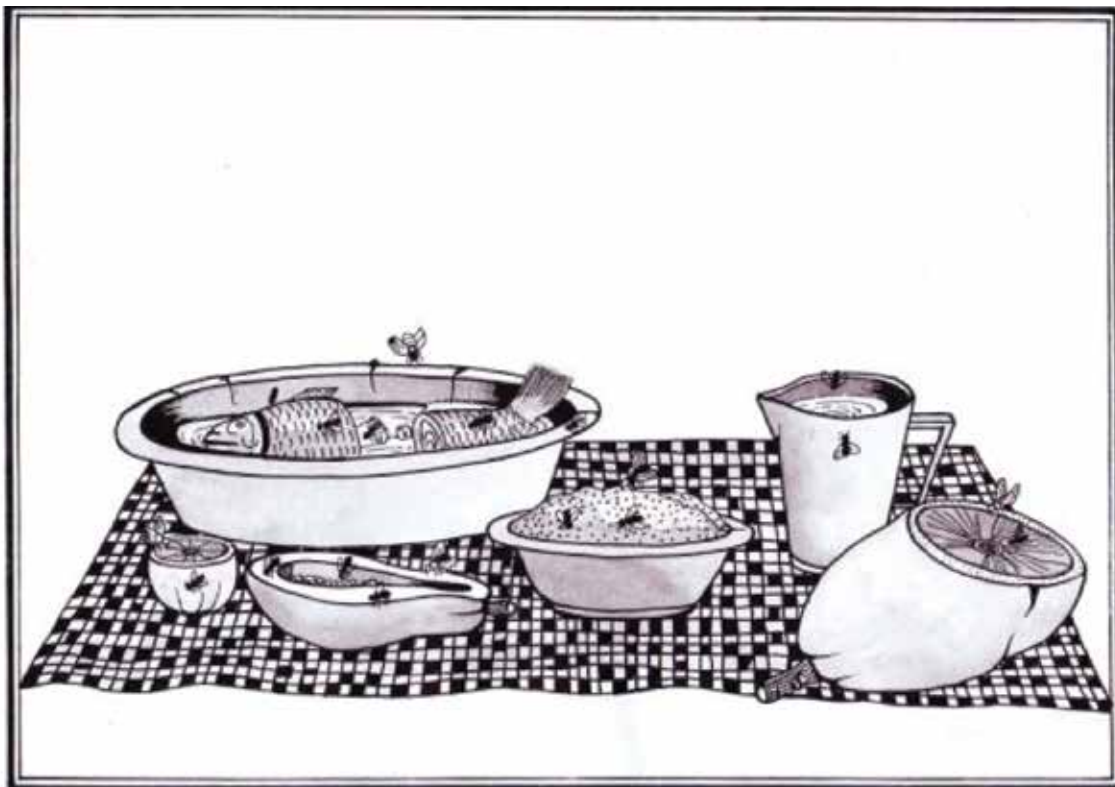
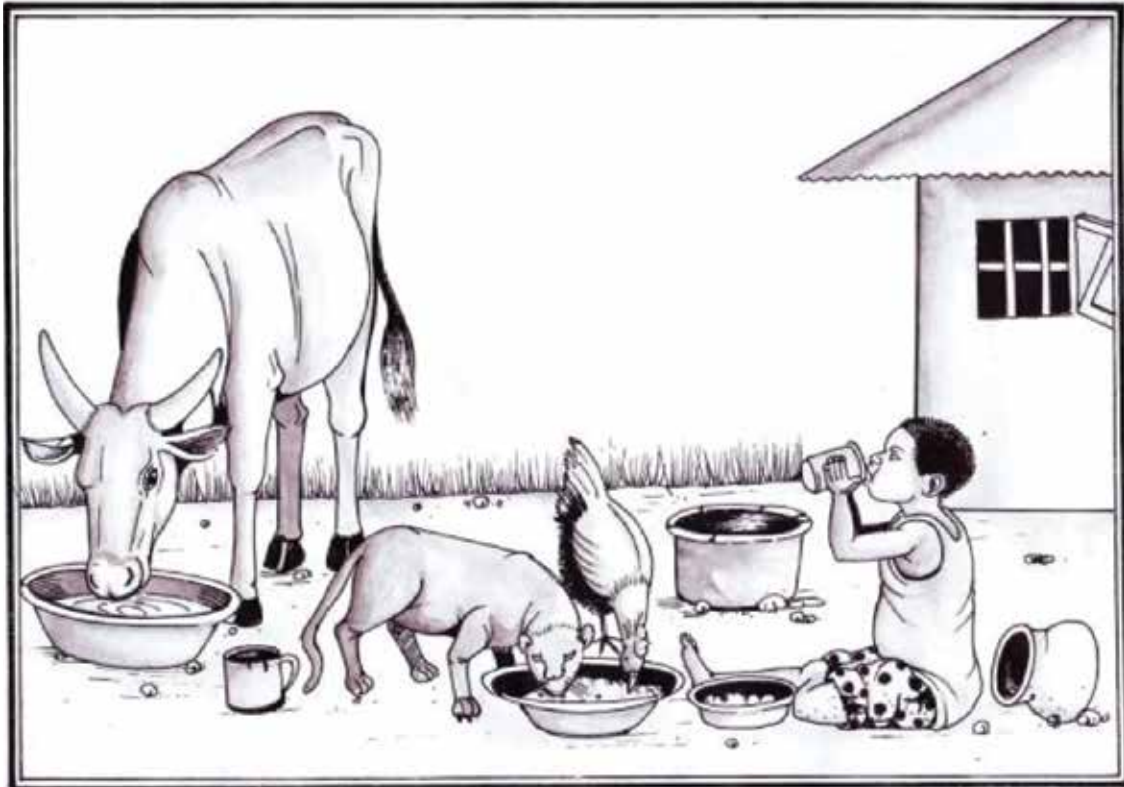

Module III

Integrating WASH into Infant and Child Nutrition Programmes

Half-day Seminar for Policy and Decision Makers to Support the Integration of WASH into Nutrition Programmes

Module III

Overview

Target

Module III is a half-day orientation on WASH and nutrition targeting various decision and policy makers at district and sub-county levels.

Objectives

By the end of the seminar participants will be able to:

1. Explain the connection between WASH and nutrition
2. Describe the consequences of poor WASH practices
3. Identify how oral-fecal transmission routes can be blocked
4. Summarize the small doable action approach for WASH behaviours
5. Support community resource persons to roll out the integration of WASH into nutrition activities

Training Material

SESSION 1

- ♦ Handout 1: Seminar Schedule

SESSION 2

- ♦ Handout 2: Integrating WASH into Nutrition Programming

SESSION 3

- ♦ Prepared flip chart: Feet, Flies, Fingers, Fields, Fluids, Food written down the middle in a landscape orientation
- ♦ Picture Card: Person practicing open defecation

- ♦ A4 papers, cut in half lengthwise or blank cards

- ♦ Markers and tape for each group

SESSION 4

- ♦ Handout 3: Small Doable Actions for WASH

SESSION 5

- ♦ Handout 4: Action Planning Template
- ♦ Handout 5: Checklist for Minimum Standards for School Sanitation and Hygiene Facilities

Schedule at-a-Glance

9:00-9:20	Session 1: Introduction to the Seminar
9:20-9:40	Session 2: Why WASH Matters for Infant and Child and Nutrition
9:40-10:00	TEA BREAK
10:00-11:30	Session 3: Blocking Fecal Contamination
11:30-12:15	Session 4: Small Doable Actions Approach
12:15-1:00	Session 5: Supporting the Integration of WASH into Nutrition Programmes
1:00	LUNCH

MODULE III SESSION PLANS

Session 1: Introduction to the Seminar

Session Learning Objectives

By the end of the session participants will be able to:

1. Describe the purpose of this seminar

Prep Work

Prepare and Bring Supplies

- ♦ Participant list
- ♦ Handout 1: Seminar Schedule

Time

20 minutes

Trainer Steps: Introduction to the Seminar

A. Introducing Participants (10 Minutes)

1. Welcome everyone to the seminar.
2. Introduce yourself by name, job function, and place of origin, sub county you represent (if appropriate), and one change you would like to see happen in your community.
3. Ask everyone else to introduce themselves the same way.

TRAINERS NOTE



It is important to note and understand key issues beyond WASH that are important to the decision and policy makers in the room. You can often get leaders to act on your issue (WASH) by connecting it to something that is important to them.

B. Purpose of the Seminar (5 Minutes)

1. Present the purpose of this seminar on a flip chart, which is to support communities to improve WASH behaviours related to nutrition.
2. Ask, what do we mean by WASH? Say Water, sanitation, and hygiene or hand washing. WA for water, S for Sanitation, H for hygiene or hand washing,
3. Ask what do we mean by WASH-Friendly?

Possible answers:

- ◆ Communities and institutions (i.e. schools) that provide sustainable latrines, handwashing facilities, safe water, and safe food preparation.
- ◆ Communities and schools that educate and promote improved WASH behaviours.
- ◆ Water systems and sanitation facilities can be accessed by ALL including the elderly and people with disabilities.
- ◆ Schools have adequate water and sanitation facilities, including separate latrines for girls.
- ◆ Market places, health facilities, and other public places have accessible and dignified (clean) water and sanitation facilities.
- ◆ Local government coordinates across ministries and ensures adequate budgets are allocated to WASH.
- ◆ Public and private sectors coordinate to support WASH improvements.

C. Introducing the Seminar Schedule (5 Minutes)

1. Pass out Handout 1: Seminar Schedule. Explain timing for each session and the total time available for the orientation.
2. Review and resolve all logistical arrangements (meals, bathrooms, tea breaks.).
3. Emphasize that this room of leaders and decision and policy makers are critical to ensuring improved development and health of our communities. This room has the power to create and sustain change!

MODULE III SESSION PLANS

Session 2: Why WASH Matters in Infant and Child Nutrition

Session Learning Objectives

1. To describe why protecting water and keeping drinking water safe, using latrines and washing hands contribute to stopping diarrhoea especially in children 0 – 24 months old
2. To learn the consequences of poor hygiene practices

Prep Work

Bring Supplies

- ◆ Handout 2: Integrating WASH into Nutrition Programming

Time

20 minutes

Trainer Steps: Why WASH Matters in Infant and Child Nutrition

A. Basic Concepts and Importance of Good Nutrition (10 Minutes)

Nutrition is a process of taking in and digesting food. The food is used for growth, reproduction, immunity, breathing, work, and health. The food is stored as nutrients and energy in appropriate parts of the body.

Malnutrition is an imbalance in nutrition status; and can be either over-nutrition or under-nutrition.



FACT BOX

Only one in eight (13 percent) children age 6-23 months were fed according to minimum standards with respect to food diversity (four or more food groups). Overall, only 6 percent of the youngest children age 6-23 months living with their mothers are fed in accordance with 3 IYCF practices – UDHS 2011

1. Explain the concepts of nutrition:
2. Emphasize that it is critical to promote optimal growth, health and development for all infants from birth to 2 years of age (i.e. the first 1000 days of infant's life). Poor

nutrition and WASH practices and high rates of infections have a detrimental impact on health and growth during these important years. Most stunting happens during months 4-16 and is basically irreversible and limits potential for life. In addition to limiting stature, stunting affects intellectual and economic potential!



In this area of Uganda, about 4 of every 10 children are stunted – small for their age. This means they are not only shorter – over 40% of our children have their learning and earning potential limited – even before they reach primary school!!!

B. The Link between Nutrition and Diarrhoea (10 Minutes)

1. A vicious cycle exists between diarrhoea and nutrition. Children with diarrhoea eat less, are less able to absorb nutrients, and become susceptible to more diarrhoea and further undernourishment.
2. Tell participants that:
 - ♦ According to the 2011 Uganda DHS, 23% of children under age five had diarrhoea in the two weeks preceding the survey.
 - ♦ Diarrhoea is the leading cause of malnutrition.
 - ♦ Under-nutrition contributes 1/3 to 1/2 of all mortality of children under 5 (WHO reports).
 - ♦ The aggregate costs of malnutrition at the national level impose a heavy burden on efforts to foster sustained economic growth and improved general welfare.
3. Tell the group that the good news is that **60% of diarrhoea is preventable through improved WASH practices!!**
4. Review the key wash practices with the

Poor WASH habits and behaviours lead to diarrhoea.

When a child or infant has diarrhoea, nutrients from food are not well-absorbed. Additionally, children with diarrhoea tend to eat less. These two factors can lead to under-nutrition.

Under-nutrition contributes to between 1/3 and 1/2 of all mortality worldwide

Undernourished children are more susceptible to diarrhoea making them further undernourished or malnourished.

Causes of Mortality for Children Under 5

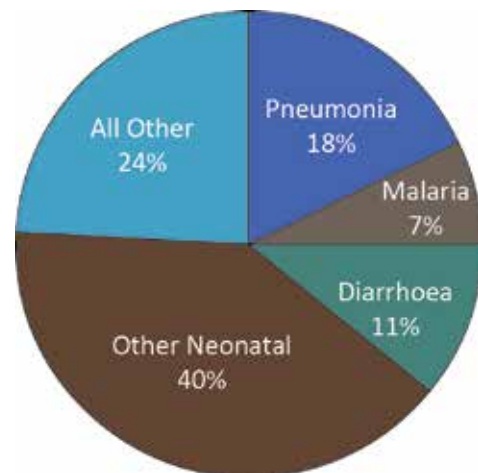

⁶Black RE, Victoria CG, Walker SP, Bhutta ZA, Christian P, de Onis M, Ezzati M, Grantham-McGregor SG, Katz J, Martorell R, Uauy R. Maternal and child undernutrition and overweight in low-income and middle-income countries. *The Lancet* 2013 382(9890): 427-451. DOI:10.1016/S0140-6736(13)60937-X

group: hand washing with soap, safe disposal of feces (including infant feces), safe storage and treatment of household drinking water, and food hygiene.

5. Pass out Handout 2: WASH and Nutrition Fact Sheet for participants to keep as a resource after the seminar.
6. Next we will look more closely at how improving WASH practices can help reduce diarrhoea and improve child growth.

MODULE III SESSION PLANS

Session 3: Blocking Fecal Contamination

Session Learning Objectives

By the end of the session participants will be able to:

1. Explain the routes that feces take from one person to another as a result of open defecation (contamination routes)
2. Identify the key barriers for blocking the “F” routes of fecal contamination

Prep Work

Prepare and Bring Supplies

- ♦ Picture Card: Person practicing open defecation
- ♦ Prepared flip chart: Feet, Flies, Fingers, Fields, Fluids, Food written down the middle in a landscape orientation (see illustration)
- ♦ A4 papers, cut in half lengthwise or blank cards
- ♦ Markers and tape for each group

Time

90 minutes

Trainer Steps: Blocking Fecal Contamination

A. Contamination Routes (45 Minutes)

1. Tell participants that we have examined the problem of the practice of open defecation and begun to look at what the consequences are of this practice on the health and well-being of adults, children and infants in the home.
2. Remind participants that feces left in the open means that:



EVERYONE IS EATING EACH OTHERS FECES!

3. Show participants the picture card of the person practicing open defecation and ask:
 - ♦ What happens when someone defecates in the open?
 - ♦ Where do the feces go?
 - ♦ What happens when it rains?

- ◆ How do the feces get from this person or that spot into our mouths to make us sick?

Possible answers:

- ◆ The rain carries feces into fields and streams and ponds. People drink contaminated water.
- ◆ People can walk through fields and track the feces into homes.
- ◆ Flies can land on the feces and then land on food.
- ◆ Hands can touch the feces and then touch others, or touch food.

4. Show the flip chart paper you prepared with the six “F” words written on it like the chart below. This will be our F-Diagram.

F-Diagram

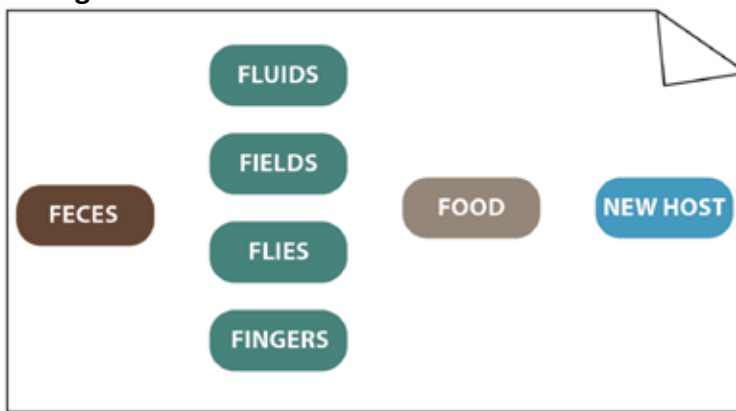

Source: Wagner and Lanois, 1958

5. Tape the open defecation picture to the left of the six “F” words written on the flip chart, where it says feces.
6. Explain that the F-Diagram (above) is an easy way to remember the routes that feces can take from one person to another and into our mouths. In more technical terms, it is called **FECAL-ORAL CONTAMINATION**. It represents the path in which germs can spread from person to person. Act this out dramatically to make the point. Point to your own backside and say **FECAL**. Bring your hand to your mouth and say **ORAL**. Repeat. Make it like a chant. Repeat 4-5 times.
7. Ask participants to give an example of feces transmission from one person to another for each “F”. As participants give answers, draw in the corresponding arrows on the flip chart F-diagram like the graphic below.

Possible answers:

- ◆ **FLIES**: land on feces, then land on uncovered food
- ◆ **FINGERS**: touch feces after defecation, then touch food or other people
- ◆ **FIELDS**: people step in it or encounter it when farming
- ◆ **FLUIDS**: runoff from fields and open defecation spots can go into streams where people get water and it gets on your hands; drinking water is stored unsafely and

gets contaminated

- FOOD: can be contaminated by unwashed hands (fingers) or by flies landing on it

F-Diagram: Possible Fecal-Oral Contamination Routes

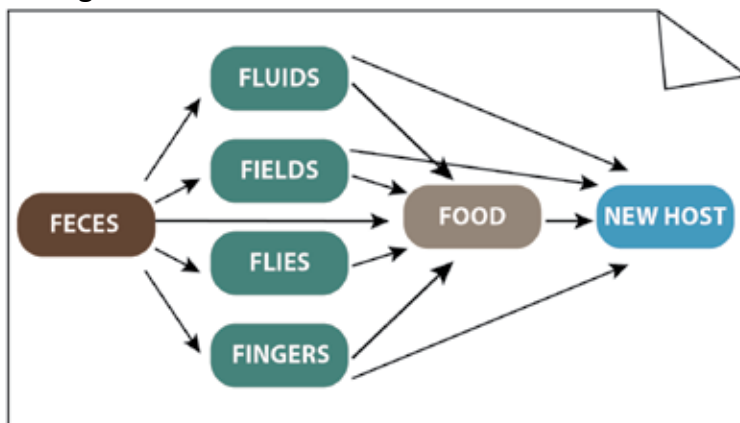

Source: Wagner and Lanois, 1958

- Emphasize FECAL (and point to your rear) –ORAL (point to your mouth) CONTAMINATION. Repeat: FECAL (and point to your rear) –ORAL (point to your mouth) CONTAMINATION.



TRAINERS NOTE

This is a serious topic, but you can make this fun!

B. How to Prevent Contamination of the Surroundings (45 Minutes)



GROUP ACTIVITY

- Restate that the F Diagram can also help us think of ways to block these contamination routes.
- Divide participants into small groups of four to five persons.
- Hand out six pieces of cut A4 paper or six cards and a marker per group.
- Ask each group to discuss what could prevent the spread of feces into our food and water supply?
- Tell each group to think of and discuss different ideas for blocking each “F” pathway and write down one key blocking or prevention behaviour for each pathway on each of the six cards.
- When groups have finished, ask one group to select and tape one prevention behaviour written on the card onto the F-Diagram flip chart paper to block the corresponding “F” feces transmission route.

7. Tell other groups to place a different response to “block” the other “F” transmission routes. Use the “F-Diagram: Primary Prevention Interventions” below to ensure all feces transmission routes have been properly blocked.

F-Diagram: Primary Prevention Interventions

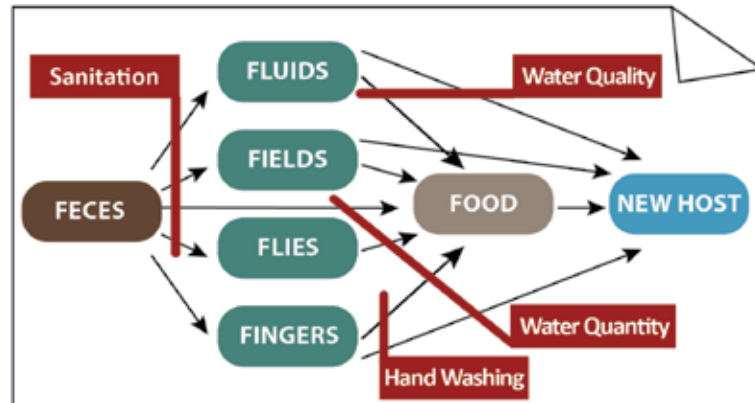

Source: Wagner and Lanois, 1958

8. Possible prevention behaviours:

- ◆ Proper latrine construction and use ... label “LATRINES”
- ◆ Proper hand washing with soap/ash after defecation Label “HAND WASHING w/ SOAP”
- ◆ Proper drinking water treatment and storage ... label “SAFE WATER”
- ◆ School compound sanitation, drainage, and proper waste management
- ◆ Proper washing of raw fruits and vegetables ... label “FOOD HYGIENE”
- ◆ Proper washing and storage of food utensils ... label “FOOD HYGIENE”
- ◆ Hand washing before preparing/eating food ... label “HANDWASHING WITH SOAP”

9. Discuss the potential benefits of the different interventions using the diagram below. Mention possible actions which householders can do in each primary prevention intervention to improve infant and child health such as:

- ◆ Use a latrine;
- ◆ Wash your hands after defecating, before preparing food, before eating or feeding someone, after cleaning a baby’s bottom;
- ◆ Safely treat your water, serve it and store it; and
- ◆ Ensure an adequate supply of water in the home for hand washing and food hygiene.

10. Ask participants to say what one or two important points or things that were learned from the session.

Possible answers:

- ◆ The first defense against open defecation is proper

F-Diagram: Primary Prevention Intervention Benefits

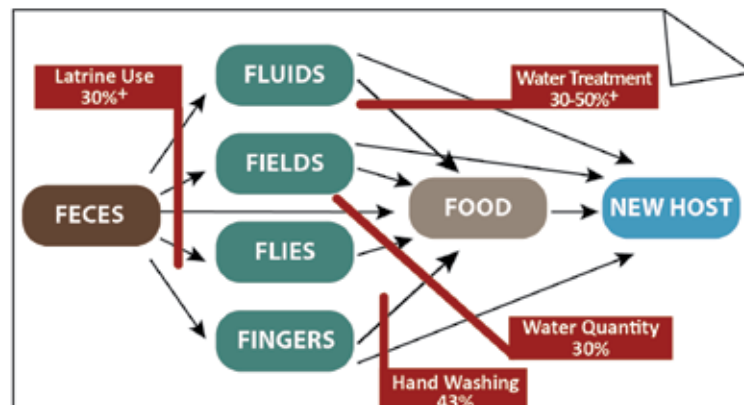

Source: Wagner and Lanois, 1958

latrine use by every member of the family, hand washing with soap or ash, and proper water storage and treatment.

- ◆ A safe latrine keeps the excreta away from people, as long as it has a cover or some other kind of seal to prevent flies and people from coming into contact with the feces.
 - ◆ Latrines have the added advantage of providing privacy when they have walls and a door or curtain. Women and girls in particular really appreciate the privacy that latrines provide.
 - ◆ After using the latrine, a person should wash his/her hands to prevent feces from making him/her sick.
 - ◆ Where there are no toilets, like in the fields, feces can be made safe by burial in the ground. Even a shallow covering of soil over the top of the excreta will prevent flies from walking on the feces. Where no other type of feces disposal system is available, burial is a clean and convenient way of disposal. For example, a person working in the fields can bury his/her feces with a hoe. This is sometimes called the “cat method.”
 - ◆ Care needs to be taken to make sure that all feces, including the feces of infants and children, are disposed of in a latrine or buried. Infants’ feces actually contain more contaminants than even adult feces.
11. There are four key WASH practices that we use to block fecal-oral transmission.



- 1. Correct handwashing with soap at key times**
- 2. Using hygienic latrines**
- 3. Treating, storing, and drinking water safely**
- 4. Practicing safe food hygiene**

12. Tell the group that these four “barriers” are tools to breaking the fecal-oral cycle. Be dramatic – point to your buttocks then to your mouth as you say fecal and oral. Tell the group we need to improve WASH practices to break the fecal-oral cycle.
13. Wrap up by telling the group that we learned how feces enters our environment and our bodies and how this leads to diarrhoea and undernutrition. We learned how to block the oral-fecal transmission routes, how to put up a barrier so infants and adults don’t ingest feces and get sick from diarrhoea; and how the barriers can reduce or eliminate diarrhoea or ingestion of feces. This is especially important for infant feeding and food preparation. In the following sessions we’ll discuss how we, as leaders and decision makers, can support behaviours to block fecal transmission.

MODULE III SESSION PLANS

Session 4: Small Doable Actions Approach

Session Learning Objectives

By the end of the module participants will be able to:

1. Explain the concept of small doable actions
2. Identify small doable actions for hand washing, safe drinking water, safe feces disposal, and safe food hygiene

Prep Work

Prepare and Bring Supplies

- ◆ Handout 3: Small Doable Actions for WASH

Time

45 minutes

Trainer Steps: Small Doable Action Approach

A. Introducing the Concept of Small Doable Actions (15 Minutes)

1. Say to the group that we've all wanted to make changes, but have felt overwhelmed with "where to start". Let's say we want to change a work habit or start exercising regularly or learn a new skill. Where do we start?
2. Tell the group that the "small doable action" approach is a best practice for behaviour change. The approach identifies a menu of feasible behaviours, from the actors point of view, that move toward the ideal practice. The small doable actions still have a positive impact, even though it is not the ideal. It's hard to go from current practices (often inadequate) to the *ideal* practice. This is true for all behaviours, including WASH behaviours.
3. Further explain that the small doable action approach involves:
 - ◆ Identifying feasible incremental steps that move people from a current hygiene practice toward the ideal practice
 - ◆ Identifying existing hygiene and sanitation good practices to be reinforced or modified
 - ◆ Identifying practices to be improved and negotiated with family member(s)

B. Small Doable Actions for WASH (30 Minutes)

1. Divide into small groups, and have each group brainstorm some small doable actions for one of the four key practices:
 - ◆ Correct handwashing at key times
 - ◆ Using hygienic latrines
 - ◆ Treating and storing safe drinking water
 - ◆ Practicing proper food hygiene
2. After ten minutes, discuss the small groups answers with the larger group.
3. Pass out Handout 3: Small Doable Actions for WASH and review together as a group to make sure key areas were covered.
4. Hand out samples of the job aids, including the assessment card, keeping water safe, food hygiene, and how to make various tippy taps.
5. Explain that outreach workers (VHTs and others) are being taught to assess then *negotiate* small doable actions, rather than the OLD way of only promoting ideal practices. Show the assessment card and the few small doable action cards. Emphasize that these are job aids for the promoters or counselors and are NOT intended to be left with households.

PROBLEM	SMALL DOABLE ACTIONS
Latrines and Feces Disposal	
◆ No resources to build a latrine	◆ Dig a shallow arbor-lou latrine with help of CLTS committee
Latrine privacy ◆ Has no door ◆ Straw wall has gaps ◆ Latrine doors are hanging/ broken hinges	◆ Hang a cloth as curtain ◆ Patch the door so it's solid, or replace with other temporary material like chitenge or other material ◆ Fix it! Often it will just take a few nails, screws, etc. for simple fixes
◆ Latrine smells ◆ Flies in latrine	◆ Look for options to increase ventilation without losing privacy ◆ Cover pit with "home fashioned" lid ◆ Put bucket of ash in latrine and have users throw a handful in after every use (ash on hands is a good hand washing agent for after defecation)
◆ No separate latrines for girls and boys ◆ No girl-friendly latrines	◆ Clearly dedicate at least half of latrines for girls ◆ Make signs "Girls Only" and "Boys Only" to mark ◆ Add a private washing station and a little mirror if possible
Hand Washing	
◆ No fixed hand washing facility	◆ Make and hang tippy tap outside of latrine
◆ No soap	◆ Buy soap and place at a handwashing station ◆ Make liquid soap ◆ Use ash if soap not accessible
◆ No easy access to water	◆ Make a tippy tap to minimize amount of water used in hand washing

PROBLEM	SMALL DOABLE ACTIONS
Water Safety & Storage	
<ul style="list-style-type: none"> ◆ Water stored in open container without lid 	<ul style="list-style-type: none"> ◆ Close container with cap ◆ Devise a convenient cover for bucket
<ul style="list-style-type: none"> ◆ Dirty cups used to get water out of storage container 	<ul style="list-style-type: none"> ◆ Make a dipper from a calabash or tin can and stick for extracting water from bucket or other receptacle ◆ Hang dipper off ground
<ul style="list-style-type: none"> ◆ Water from unprotected spring, shallow well, or other unsafe source 	<ul style="list-style-type: none"> ◆ Filter water to remove dirt and then treat water by boiling, solar disinfecting or chlorinating
Food Safety & Storage	
<ul style="list-style-type: none"> ◆ No handwashing facility near cooking/eating area 	<ul style="list-style-type: none"> ◆ Hang tippy tap by cooking/eating area
<ul style="list-style-type: none"> ◆ Food stored in open containers ◆ Flies near stored food 	<ul style="list-style-type: none"> ◆ Devise simple covers for food storage
<ul style="list-style-type: none"> ◆ No dedicated food preparation area ◆ Food preparation area on the ground ◆ Food preparation area not washed daily 	<ul style="list-style-type: none"> ◆ Create small, raised separate space for food preparation ◆ Keep soap and water nearby to wash food preparation area daily
<ul style="list-style-type: none"> ◆ Raw foods not cleaned before consumption 	<ul style="list-style-type: none"> ◆ Ensure easy access to clean water to rinse fruits and vegetables eaten raw

MODULE III SESSION PLANS

Session 5: Supporting the Integration of WASH into Nutrition Programmes

Session Learning Objectives

By the end of the module participants will be able to:

1. Identify ways to support lower level cadres to roll out an integrated WASH and Nutrition programme

Prep Work

Prepare and Bring Supplies

- ◆ Handout 4: Action Planning Template
- ◆ Handout 5: Checklist for Minimum Standards for School Sanitation and Hygiene Facilities

Time

45 minutes

Trainer Steps: Supporting the Roll Out of an Integrated WASH and Nutrition Programme

A. Roles in Supporting Lower Level Cadres (10 Minutes)

1. Explain that the purpose of this session is to enable participants to identify our own small doable actions they can do to support lower level cadres roll out the integrated WASH/Nutrition programme in communities and schools. Emphasize that just like households, as planners we rarely go from a current practice to the ideal. So we can apply this same small doable action approach to our planning.
2. Ask the group what small doable actions they see for integrating WASH into nutrition programme platforms.
3. Ask the group what kind of support might lower level cadres need to integrate WASH and nutrition?

Possible answers:

- ◆ Coordination, mobilization, and/or budget support for standardized messages, materials, training and household visits with village health teams, community knowledge workers, peer support groups, and teachers.

- ◆ Support for sanitation and hygiene standards at schools
 - ◆ Assessment of school needs
 - ◆ Encouraging specific small doable actions for schools like building tippy tap handwashing stations with soap, repairing/creating latrine walls, assigning girl and boy bathrooms
 - ◆ Coordinate school WASH clubs to lead small doable actions
 - ◆ Budget for new latrines and safe sources of drinking water when needed

B. Developing an Action Plan (35 Minutes)

1. Pass out Handout 4: Action Plan to Support Integrated WASH and Nutrition Programmes. Review the template together.
2. Pass out Handout 5: Checklist for Minimum Standards for School Sanitation and Hygiene Facilities. Tell the participants they can use this to guide them in thinking about ways to support WASH in schools.
3. Divide the participants into their district groups and give them 20 minutes to develop their action plan.
4. After the action plans are developed. Give each group a chance to present their ideas.
5. Thank everyone for a wonderful seminar. Remind them that they are critical to ensuring improved child nutrition and health in their communities.

Module III

Handouts

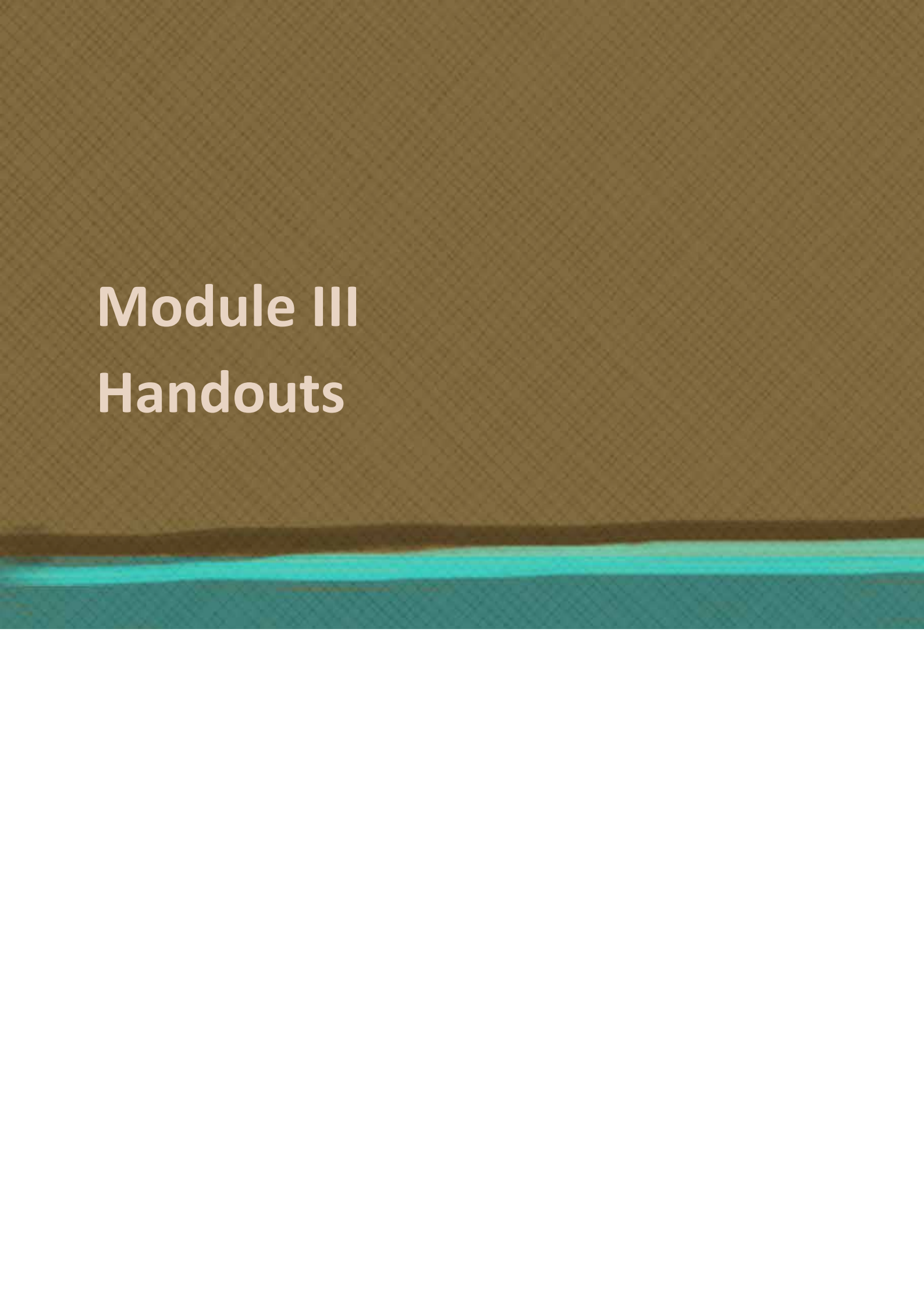

Supporting the Integration of WASH into Nutrition Programmes

Seminar Schedule

9:00-9:20	Session 1: Introduction to the Seminar
9:20-9:40	Session 2: Why WASH Matters for Infant and Child Health and Nutrition
9:40-10:00	TEA BREAK
10:00-11:30	Session 3: Blocking Fecal Contamination
11:30-12:15	Session 4: Small Doable Actions
12:15-1:00	Session 5: Supporting the Integration of WASH into Nutrition Programmes
1:00	LUNCH



INTEGRATING WASH INTO NUTRITION PROGRAMMING

BACKGROUND

Diarrhea, pneumonia and birth complications are the top three killers of children under age 5 worldwide.¹ Each year diarrhea alone causes the death of 760,000 children under 5 (11 percent of all child mortality).² Diarrhea is also a leading cause of undernutrition in this age group and one-third to one-half of all child mortality cases are linked to undernutrition.^{3,4} UNICEF estimates that more than 90 percent of deaths from diarrheal illnesses in young children can be attributed to unsafe or inadequate water, sanitation, and hygiene (WASH) practices.⁵ If mothers and other caregivers used basic hygiene practices and had better access to safe water and adequate sanitation this could greatly reduce under 5 deaths and improve child nutrition.

Recent studies suggest that after a period of exclusive breastfeeding in the early months of life, children 6–17 months of age show an increase in the incidence of diarrhea that correlates with the introduction of complementary feeding.⁷ In developing countries, children under age 2 experience an average of three episodes of diarrhea, most between 6–11 months of age.⁸ Unsafe water was considered the primary cause of diarrhea in children transitioning from an exclusive breastfeeding diet, but recent evidence also points to unsafe food.⁹ In 2009, the World Health Organization's (WHO) head of food safety noted that a WHO analysis determined unsafe food kills an estimated 1.2 million people over age 5 in Southeast Asia and Africa each year.¹⁰ This statistic serves as an informal proxy of contamination levels in complementary and weaning foods ingested by young children and reinforces the issue of food hygiene as a critical practice to address.

According to UNICEF, stunting—height for age—is the most reliable measure of undernutrition because it accounts for food intake, caloric or protein deficiency, and periods of ill health.¹¹ Undernutrition is the underlying cause of 35 percent of child deaths each year.¹² Undernutrition is not just lack of food. Three factors are important for adequate nutrition:

- Access to food
- Maternal and child care practices
- Access to WASH to prevent diarrhea

Other factors can also inhibit a child's access to food, such as poverty, discrimination, and political marginalization.

A vicious cycle exists between diarrhea and undernutrition: children with diarrhea eat less and are less able to absorb the nutrients from their food; malnourished children

Causes of Mortality for Children Under 5⁶

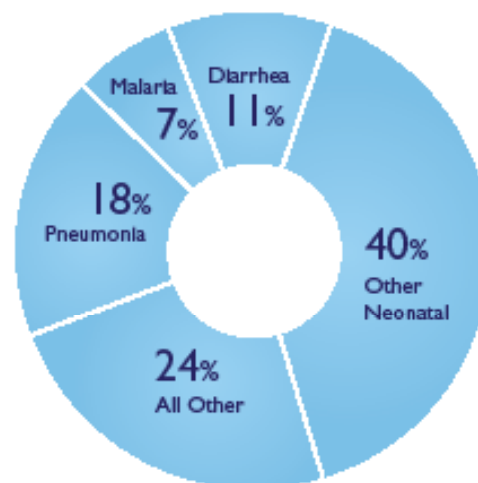

are more susceptible to diarrhea when exposed to fecal material from their environment. Further, often the most vulnerable children do not have access to the health services that can mean the difference between life and death in the case of acute diarrhea.

New research is underway to document the evidence base for the connection between WASH and undernutrition. Currently, USAID, with WHO and UNICEF, is collecting evidence and documenting concrete programming actions to integrate WASH and nutrition to prevent diarrheal disease and undernutrition and improve child health outcomes. Too often, low-cost, high-impact WASH interventions are overlooked. Yet these simple actions can prevent diarrhea and undernutrition even in hygiene-challenged environments. This brochure highlights some of these WASH interventions.

KEY WASH PRACTICES AND GUIDANCE*

Hygiene practices have been proven to reduce diarrhea rates by 30–40 percent.^{13,14} This level of reduction can be achieved through a comprehensive approach—promoting improvements in key hygiene practices (hand washing, treatment and safe storage of drinking water, safe disposal of feces, and food hygiene); improving access to safe water and sanitation technologies and products; and facilitating or supporting an enabling environment (improved policies, community organization, institutional strengthening, and public-private partnerships).

Optimal Hand Washing

Hand washing prevents diarrhea effectively when done properly and at critical times. A meta-analysis of hand washing studies conducted in developing countries concluded that hand washing can reduce the risk of diarrhea in the general population by 42–44 percent.¹⁵ A recent observational study in Bangladesh found that diarrhea occurred less often in households where residents washed at least one hand after defecation and before preparing food. The study suggested that washing hands before preparing food is particularly important to prevent diarrhea in children.¹⁶

How and When to Wash Hands

- Use soap or ash every time you wash your hands.
- Wash hands under poured or flowing water. This removes the dirt and germs. A washbasin in which many people wash their hands in the same water does not prevent infection.
- Wash hands before handling, preparing, or eating food; before feeding someone or giving medicines; and wash hands often during food preparation.
- Wash hands after going to the toilet, cleaning a person who has defecated, blowing your nose, coughing, sneezing, or handling an animal or animal waste, and both before and after tending to someone who is sick.

Treatment and Safe Storage of Household Drinking Water

Treatment and safe storage of drinking water in the household have been shown to reduce the risk of diarrheal disease by 30–40 percent.¹⁷ Conclusive evidence shows that simple, low-cost strategies can greatly improve the microbial quality of water and result in diarrheal disease morbidity reductions comparable to those achieved by hand washing and sanitation.

*The content of this section was adapted from: USAID Hygiene Improvement Project. *Programming Guidance for Integrating Water, Sanitation and Hygiene Improvement into HIV/AIDS Programs*. Washington, DC: HIP/AED.



© 2009 Anindya Phani, Courtesy of Photoshare

Water Treatment Methods¹⁸

Households should first separate drinking water from other household water. Treat all drinking water using an effective treatment method as listed below, and then store safely (see storage details that follow).

- Chlorination
- Boiling
- Solar disinfection (SODIS) using heat and UV radiation
- Filtration using different types of filters
- Combined chemical coagulation, flocculation, and disinfection¹⁹

Water Storage Methods

- Store treated water in an appropriate vessel preferably with a narrow neck and a tap.
- If the container does not have a tap, pour the water into a clean pitcher to serve or use a ladle to dispense water.
- Hang the ladle on the wall.
- Do not touch the inside of the container with hands.

Sanitation/Feces Management

Safe disposal of feces reduces the risk of diarrheal disease by 30 percent or more.²⁰ Best practices for latrine use are listed below. All household members should handle and dispose of feces safely by defecating in a hygienic latrine. Children and people with limited mobility should use adaptive technologies.

- Ensure a latrine meets minimum standards, including a cleanable platform, a cover over the pit, housing that provides privacy, and a hand washing station nearby (ideally located next to the latrine and/or cooking area). If a latrine is not available, sharing with others in the community should be considered, or, in the interim, burying feces away from the house or facility.
- Maintain latrines properly by clearing the path to the latrine, removing obstacles such as stones and branches, and filling holes in the path to facilitate easier access. The platform, seat, walls, or other surface of the latrine should be feces free. All anal cleansing materials should be placed in the latrine itself. A scoop of lime or ash in the latrine after defecation can reduce odors and deter flies.
- Modify latrines for children and people with limited mobility. The modifications may require building supports (poles, ropes, stools) to make children or weak household members comfortable using the latrine or providing simple commodes to place over the latrine pit or bedpans/potties.

Food Hygiene

Relatively little evidence currently exists about the importance and benefits of good food hygiene practices. WHO published a document called Five Keys to Safer Food²¹ that describes actions families should take in the kitchen to maintain food safety.

1. Keep food preparation areas clean.

- Wash all surfaces and equipment used to prepare or serve food with soap and water and if possible, with bleach.
- Protect food from insects, pests, and other animals by covering food with netting, a cloth, or keeping it in containers.

2. Separate raw and cooked food.

- Raw eggs, meat, poultry, fish, and seafood can easily contaminate other foods with illness-causing bacteria. Keep them away from other foods.
- Use separate equipment and utensils such as knives and cutting boards to handle raw foods.
- Store foods in covered containers to avoid contact between raw and cooked foods.

3. Cook food thoroughly.

- Cook food thoroughly, especially meat, poultry, eggs, fish, and seafood. For meat and poultry, make sure juices are clear, not pink.

- Bring soups and stews to the boiling point until the first big bubble is seen.
- Reheat cooked food thoroughly; bring it to a boil or heat it until it is too hot to touch. Stir while reheating.

4. Keep foods at safe temperatures.

- Do not leave cooked food at room temperature for more than two hours.
- Reheat cooked food that has been stored before reserving.
- Do not thaw frozen food at room temperature.
- Prepare fresh food for infants and young children and other people with compromised immune systems and do not store it after cooking.

5. Use safe water and raw materials.

- Choose fresh and nutrient-rich foods.
- Do not use food beyond its expiry date.
- Use pasteurized milk or boil milk before use.
- Wash raw vegetables/fruits with treated water or peel the skin before eating.

An upcoming USAID/WHO/UNICEF publication on integrated WASH and nutrition programming will suggest feasible, effective actions related to these practices. The section that follows provides information on integrating WASH into various aspects of nutrition programming.

INTEGRATING WASH INTO A NUTRITION ASSESSMENT

This list of questions may be too exhaustive to include in a nutrition assessment, but it is important to ask some questions for each WASH practice to get people to think about different areas of WASH. The questions highlighted in bold are the highest priority for use if time is limited. Validated survey instruments for the WASH questions can be found online at: www.measuredhs.com/publications/publication-DHSQ6-DHS-Questionnaires-and-Manuals.cfm (questions 102–109 for water and sanitation; questions 138–139 for hand washing).

Household Drinking Water

1. Where do you get your drinking water?
- 2. Do you treat your drinking water? If so, how?**
- 3. Where do you store treated drinking water?**
4. How do you serve/give people water to drink (pour from jug, dipper, etc.)?

HANDOUT 2 ♦ BRIEF: INTEGRATING WASH INTO NUTRITION PROGRAMMING

Sanitation

1. **Do you have a latrine?** Can you show it to me?
2. **Who uses the latrine?**
3. **How often do family members use this latrine?**
4. Does anyone in your house need help to use the latrine?
5. Do your children use the latrine? If not, where do they defecate?

Hand Washing

1. **Where do you wash your hands? Can you show me?**
2. **When do you wash your hands?**
3. How do you wash your hands?

Food Hygiene

1. Where do you prepare food for cooking?
2. **Do you wash the food preparation surfaces? When do you wash them? How do you wash them?**
3. Do you wash your food before cooking? Which foods do you wash before cooking?
4. **Where do you store (cooked/prepared) food? For how long?**
5. Do you reheat stored food?

INTEGRATING WASH INTO NUTRITION COUNSELING AND PROMOTION

Make hand washing an “essential nutrition action” and incorporate the practice into all counseling and promotional materials. Counselors need to work with mothers and others being counseled to negotiate actions for families to take to improve drinking water, hand washing, sanitation, and food hygiene. Through an assessment of the current WASH practices of the family, counselors can reinforce existing good practices and help identify a few improvements (small doable actions) that can be made that are feasible and effective incremental steps toward reaching an ideal WASH practice. Counselors can discuss with caregivers what might make it easier or more difficult to try a new practice and help them to find possible solutions. Counselors should choose one or two focus areas that families feel they could improve upon successfully.

INTEGRATING WASH INTO TARGETED HEALTH ACTIVITIES (e.g., distribute point-of-use water (POU) treatment or vouchers for POU water treatment)

Distributing a safe water kit to women during health facility visits has proven to be an effective incentive to increase use of antenatal care (ANC) services, HIV testing services, and facility delivery. Households given safe water kits that include a water treatment product, a water storage container, and soap were also more likely to purchase hypochlorite solution one year after receiving the free kit and use water treatment products regularly; their neighbors were more likely to use them as well. Studies show women who received kits had more ANC visits (10–15 percent). Such incentives have proven to be effective in bringing new clients into preventing mother-to-child transmission programs, bringing clients in earlier for ANC visits, and sustaining attendance through assisted delivery and postpartum care.²²

Some countries distribute a basic care package to people living with HIV. This basic care package includes a water container, hypochlorite solution, information on hand washing, a treated bednet for malaria prevention, and sometimes a bar of soap. This package could also include materials on how and when to wash hands, how to build a water-saving hand washing device called a tippy tap, how to build a latrine, how to manage feces in the home safely, and how to prepare foods safely.



© 2008 Kunle Ajayi, Courtesy of Photosha



© 2010 Jessica Scranton, FHI 360

INTEGRATING WASH INTO COMMUNITY SERVICES

Countries have different types of community service workers who can reinforce improved WASH practices during caregiving, help families learn more about improved WASH, and connect families with support or services to improve their WASH practices. These community workers include the following: health workers who are often trained to identify health problems and treatment options and to promote improved health practices; early child development workers who may take care of young children while parents work; and home-based care workers who work in communities with clients who are too sick to care for themselves.

INTEGRATING WASH INTO MATERNAL AND NEONATAL PROGRAMS

A study in Nepal²³ found that mortality was significantly lower among newborns whose birth attendant or mother washed her hands with soap. Similarly, the Alive & Thrive project in Bangladesh found that hand washing with soap before handling children’s food supports normal growth in infants and young children.^{24,25}

USAID supports effective program approaches—such as essential newborn care, linking maternal and newborn programs in a continuum of care, and early postnatal visits. Increased emphasis on hand washing is an easy and cost-effective way to complement and strengthen these activities. The objective is to ensure birth attendants wash hands with soap before delivery, and mothers and

caregivers wash hands with soap before handling the newborn. Specific suggestions include:

Birth Kits

- Ensure that soap is included in the clean birthing kit.
- Design a card on proper hand washing techniques for new mothers, caregivers, and birth attendants for inclusion in the kit.

Antenatal Care

- Incorporate hand washing as an “essential ANC action.”
- Develop a session on hand washing to include in all birth counseling courses.

Hand Washing

- Address barriers to hand washing, such as water scarcity, by demonstrating how to build simple water-saving devices (such as a tippy tap) from locally available materials. A tippy tap should be placed in the clinic or household in an easily accessible location to facilitate hand washing among birth attendants and new mothers in water-scarce settings.
- Include hand washing information and education in all community approaches to newborn health.
- Include newborn care messaging in existing WASH programs, including public-private partnerships.

ENDNOTES

- 1 Liu et al. 2012. Global, Regional, and National Causes of Child Mortality: An Updated Systematic Analysis for 2010 with Time Trends since 2000. *The Lancet* 379, 2151 – 2161.
- 2 WHO. 2013. *Diarrhoeal Disease*. Fact sheet N°330. Geneva: World Health Organization.
- 3 Bryce et al. 2005. [WHO Estimates of the Causes of Death in Children](#). *The Lancet* 365: 1147–52.
- 4 WHO. 2012. *Children: Reducing Mortality*. Fact sheet N°178. Geneva: World Health Organization.
- 5 UNICEF. 2012. *Children and Water: Global Statistics*. New York: United Nations Children’s Fund. http://www.unicef.org/wash/index_31600.html
- 6 Child Health Epidemiological Research Group (CHERG). 2012. <http://cherg.org>
- 7 Stallings. 2004. Child Morbidity and Treatment Patterns. *DHS Comparative Reports*. No. 8. Calverton, Maryland: ORC Macro.
- 8 Kosek et al. 2005. The Global Burden of Diarrhoeal Disease, as Estimated from Studies Published between 1992 and 2000. *WHO Bulletin* 81:197–204.
- 9 Harris et al. 2009. Effect of a Point-of-Use Water Treatment and Safe Water Storage Intervention on Diarrhea in Infants of HIV-Infected Mothers. *The Journal of Infectious Diseases*. 200(8): 1186–1193.
- 10 Kaiser Foundation. 2009. *Updated WHO Data Finds Deaths Caused by Tainted Food Are Underestimated*. Kaiser Daily Global Health Policy Report. Kaiser Family Foundation.
- 11 UNICEF. 2012. *State of the World’s Children*. Op. cit.
- 12 Black et al. 2008. Op. Cit.
- 13 Curtis and Cairncross. 2003. Effect of Washing Hands with Soap on Diarrhea Risk in the Community: A Systematic Review. *The Lancet* 3: 275-281.
- 14 Fewtrell et al. 2005. Water, Sanitation, and Hygiene Interventions to Reduce Diarrhea in Less Developed Countries. A Systematic Review and Meta-Analysis. *The Lancet Infectious Diseases* 5(1):42-52.
- 15 Curtis and Cairncross. 2003. Op. Cit.
- 16 Luby et al. 2011. The Effect of Handwashing at Recommended Times with Water Alone and with Soap on Child Diarrhea in Rural Bangladesh: An Observational Study.” *PLOS Medicine* 8(6):e1001052.
- 17 Clasen et al. 2006. Interventions to Improve Water Quality for Preventing Diarrhoea. (A Cochrane Review). In: *The Cochrane Library*, Issue 3, 2006. Oxford: Update Software.
- 18 CDC. 2012. *Household Water Treatment*. <http://www.cdc.gov/safewater/household-water.html>
- 19 Ibid.
- 20 Fewtrell et al. 2005. Op. cit.
- 21 WHO. 2012. *Five Keys to Safer Food*. <http://www.who.int/foodsafety/consumer/5keys/en/>
- 22 USAID/HIP. 2012. *Programming Water, Sanitation and Hygiene (WASH) Activities in U.S. Government Country Operational Plans (COPs): A Toolkit for FY2013 Planning*. Washington, DC: USAID.
- 23 Rhee V. et al. 2008. Maternal and Birth Attendant Hand Washing and Neonatal Mortality in Southern Nepal. *Archives of Pediatrics & Adolescent Medicine*. 162(7): 603–608.
- 24 FHI 360. 2012. *Why Hand Washing Is Critical to Child Health and Nutrition in Bangladesh— How to Make it a Reality*. Washington, DC: Alive & Thrive project.
- 25 Luby et al. 2011. Op. cit.

PROBLEM	SMALL DOABLE ACTIONS
Latrines and Feces Disposal	
<ul style="list-style-type: none"> ◆ No resources to build a latrine 	<ul style="list-style-type: none"> ◆ Dig a shallow arbor-lou latrine with the help of the CLTS committee
<p>Latrine privacy</p> <ul style="list-style-type: none"> ◆ Has no door ◆ Straw wall has gaps ◆ Latrine doors are hanging/ broken hinges 	<ul style="list-style-type: none"> ◆ Hang a cloth as curtain ◆ Patch the door so it's solid, or replace with other temporary material like chitenge or other material ◆ Fix it! Often it will just take a few nails, screws, etc. for simple fixes
<ul style="list-style-type: none"> ◆ Latrine smells ◆ Flies in latrine 	<ul style="list-style-type: none"> ◆ Look for options to increase ventilation without losing privacy ◆ Cover pit with "home fashioned" lid ◆ Put bucket of ash in latrine and have users throw a handful in after every use (ash on hands is a good hand washing agent for after defecation)
<ul style="list-style-type: none"> ◆ No separate latrines for girls and boys ◆ No girl-friendly latrines 	<ul style="list-style-type: none"> ◆ Clearly dedicate at least half of latrines for girls ◆ Make signs "Girls Only" and "Boys Only" to mark ◆ Add a private washing station and a little mirror if possible
Hand Washing	
<ul style="list-style-type: none"> ◆ No fixed hand washing facility 	<ul style="list-style-type: none"> ◆ Make and hang tippy tap outside of latrine
<ul style="list-style-type: none"> ◆ No soap 	<ul style="list-style-type: none"> ◆ Buy soap and place at a handwashing station ◆ Make liquid soap ◆ Use ash if soap not accessible
<ul style="list-style-type: none"> ◆ No easy access to water 	<ul style="list-style-type: none"> ◆ Make a tippy tap to minimize amount of water used in hand washing
Water Safety & Storage	
<ul style="list-style-type: none"> ◆ Water stored in open container without lid 	<ul style="list-style-type: none"> ◆ Close container with cap ◆ Devise a convenient cover for bucket
<ul style="list-style-type: none"> ◆ Dirty cups used to get water out of storage container 	<ul style="list-style-type: none"> ◆ Make a dipper from a calabash or tin can and a stick for extracting water from bucket or other receptacle ◆ Hang dipper off ground
<ul style="list-style-type: none"> ◆ Water from unprotected spring, shallow well, or other unsafe source 	<ul style="list-style-type: none"> ◆ Filter water to remove dirt and then treat water by boiling, solar disinfecting or chlorinating
Food Safety & Storage	
<ul style="list-style-type: none"> ◆ No handwashing facility near cooking/eating area 	<ul style="list-style-type: none"> ◆ Hang tippy tap by cooking/eating area
<ul style="list-style-type: none"> ◆ Food stored in open containers ◆ Flies near stored food 	<ul style="list-style-type: none"> ◆ Devise simple covers for food storage
<ul style="list-style-type: none"> ◆ No dedicated food preparation area ◆ Food preparation area on the ground ◆ Food preparation area not washed daily 	<ul style="list-style-type: none"> ◆ Create small, raised separate space for food preparation ◆ Keep soap and water nearby to wash food preparation area daily
<ul style="list-style-type: none"> ◆ Raw foods not cleaned before consumption 	<ul style="list-style-type: none"> ◆ Ensure easy access to clean water to rinse fruits and vegetables eaten raw

HANDOUT 4 ♦ ACTION PLANNING TEMPLATE

Key Result Area for Change	Proposed Small Doable Action	Time Frame	Indicators for Progress	Responsible Person

Checklist for Minimum Standards for School Sanitation and Hygiene Facilities

- Separate latrines for boys and girls
- “Child-friendly” facilities
- Latrines for male and female teachers
- 1 latrine per 25 girls and 1 for female staff
- 1 latrine + 1 urinal per 50 boys and 1 for male staff
- Hand washing stations next to latrines

Latrines should have:

- Walls and roof
- Ventilation
- Doors that lock from the inside, not the outside
- Washable slabs
- Anal cleansing material (paper, leaves, water)
- Wastebasket for used wiping material
- A place to wash hands after use

Hand washing stations should have (at least):

- Basin
- Source of running water for rinsing (tap, jug)
- Soap, ash, clean sand, or mud
- Soak pit to avoid standing water

Cleaning materials

- Cleaning items such as broom, scrub brush, etc.

Adapted From: Water, Sanitation and Hygiene Standards for Schools in Low-cost Settings (WHO, UNICEF 2009)

WASH Integration Job Aids



Small Doable Actions for Improving Household Water, Sanitation, and Hygiene Practices

Job Aids for
Village Health
Teams, Peer
Educators, and
their Supervisors

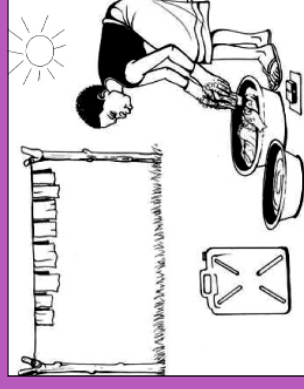
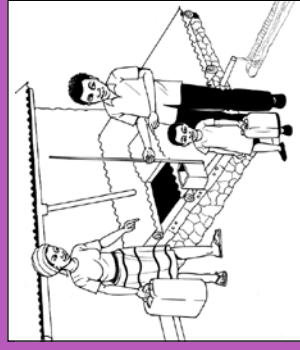
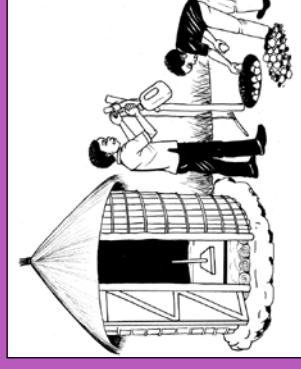

USAID
FROM THE AMERICAN PEOPLE



washplus
Supportive Environments for Healthy Communities

ACKNOWLEDGEMENTS

This Republic of Uganda Ministry of Health (MOH) publication was prepared with financial and technical support from the WASHplus project with funding from the United States Agency for International Development (USAID). The programme would like to recognize Mariella Ruiz-Rodriguez, USAID/Uganda, for her commitment to WASH Integration in Uganda. This activity would not have been possible without the dedicated support of the USAID implementing partners, including SDS (Strengthening Decentralization for Sustainability), SPRING (Strengthening Partnerships, Results, and Innovations in Nutrition Globally), STAR-SW (Strengthening TB and HIV/AIDS Response in the Southwest), and Community Connector, as well as the District Health Inspectors of Kisoro, Kanungu, and Kabale. They are committed and integral partners and have helped to bring this activity to the districts of Uganda and ultimately to the communities themselves.

The job aids were adapted from similar cards previously developed for Ethiopia, Kenya, and Uganda by other team members of the USAID/Hygiene Improvement Project, including Renuka Bery, Julia Rosenbaum, Eleonore Seumo, and Elizabeth Younger. Juliet Nandawula and Julia Rosenbaum revised the counselling cards based on pretesting with selected district health officers/inspectors, village health teams, and peer educators through the MOH and USAID implementing partners Community Connector, STAR-SW, SPRING, and others.

INTRODUCTION

This set of job aids is designed to help a range of community- and clinic-based workers communicate effectively on water, sanitation, and hygiene (WASH) practices with priority groups, including mothers and caregivers of young children, vulnerable families, and people affected by HIV.

A vicious cycle exists between diarrhoea and good growth. Improving WASH practices—safe faeces disposal; hand washing with soap; and safe transport, handling, and storage of household water helps to prevent diarrhoeal diseases, and reduces morbidity and mortality in people living with HIV and in children under 5. Improving WASH practices, including menstrual hygiene management and the other WASH behaviours outlined above helps improve the whole family's health and quality of life, leaving more time for school, income generation, and quality of life.

WASHplus, a five-year (2010–2015) cooperative agreement (AID-OAA-A-10-00040) implemented by FHI 360 with CARE and Winrock International as core partners, is funded through USAID's Bureau for Global Health. WASHplus creates supportive environments for healthy households and communities by delivering interventions that lead to improvements in access, practices, and health outcomes related to WASH, and household air pollution. WASHplus uses at-scale as well as integrated programming approaches globally to reduce diarrhoeal diseases and acute respiratory infections, the two top killers of children under 5 years of age. For information, visit www.washplus.org or email: contact@washplus.org.

CONTACT INFORMATION

USAID WASHplus Project
FHI 360
1825 Connecticut Avenue, NW
Washington, DC 20009-5721
Communication via: jrosenbaum@fhi360.org

USING THIS GUIDE

As a village health team, peer educator, or clinic-based health worker, you have two tasks in using this guide:

1. Use improved WASH practices in your health centre, community, and home visits.
2. Support households to improve their WASH practices at all times. Instead of 'teaching' or 'promoting' improved WASH practices, think about helping to counsel and problem solve **so the interaction ends with a commitment to adopt the new behaviour and that all households have the needed skills, confidence, and information to do so.**

These cards are designed to help you do your job and remind you of key information about a range of WASH issues. All the cards are focused on improving WASH behaviours or practices, and the cards focus on doable action steps that move toward ideal WASH practice. **These are your tools, specially designed by you and for you! They help remind you and help you change WASH practices for the better.**

When counselling in the clinic or reaching out to households and communities, you can use the following steps:

- a. Explore current WASH practices and identify a few priority practices for improvement.
- b. Explain the behaviour you will focus on, and use the job aid card to illustrate the steps to follow.
- c. Demonstrate, if possible, or explain in an active way, how the task is performed.
- d. Encourage the caregiver or household head to try the task.
- e. Give feedback. Help solve problems or address doubts.
- f. Recognize the caregiver or household head for trying, and emphasize at least one thing they've done well. Highlight particular actions that need to be improved and show how to improve them.
- g. Get a commitment from clients that they will try the new behaviour.
- h. Follow up at the next visit.

More suggestions on being a good communicator follow below.

To identify which WASH practice to focus on, use the assessment card to determine how well the household is practicing each WASH area. Congratulate the client about existing good WASH practices, decide with the client/household which WASH practice(s) is/are feasible to improve. For most WASH behaviours, we've identified a 'menu' of small doable actions (SDA) to select from, and then negotiate.

Below is a description of the steps required to do these tasks. The individual cards that follow demonstrate how to improve specific WASH practices.

Remember, people find it hard to jump from their current practice to the ideal. It's easier to take steps towards the ideal behavior, but those steps need to seem possible to the client, and have an impact if practiced. We call these steps towards the ideal **small doable actions.**

NEGOTIATING IMPROVED WASH PRACTICES

Helping the client and household succeed in improving their WASH practices requires good preparation, an effective WASH negotiation session, and regular follow-up visits from outreach workers.

Step 1: Prepare for a negotiation session

- Review the content of the cards and bring them to the households you visit, or have them present at the clinical session.
- For each WASH behaviour, familiarize yourself with the small doable actions to assess and negotiate.

Step 2: Conduct an effective negotiation session

► *Make a good contact with the client and any household members in attendance*

- Greet the client and household members
- Introduce yourself and explain objectives of your visit
- Ask to talk about WASH practices with household head

► *Assess the household's current WASH practices*

- Guided by the assessment card, ask questions and observe current WASH practices
- In the clinical session the practices may 'come up' in conversation or intake

► *Identify the WASH practices already implemented and congratulate the client and household members*

- Compare the household's current WASH practices with the SDA on the assessment card and identify what the client and household members are already implementing
- Congratulate the client and household member for implementing the SDA
- Encourage the client and household members to continue to implement these SDA

► *Decide the WASH practice to be improved*

If the household or client has multiple WASH behaviours that need improvement, select one behaviour to start. Make the selection based on the following criteria:

- Materials/commodities/products available to the household
- Whether it is easy to implement
- Importance/impact of practicing or not practicing the WASH behaviour
- Approval of the client

Steps for Effective Negotiation

- Make good contact with household members
- Assess current WASH practices
- Identify WASH practices already implemented and congratulate household members
- Select WASH practice to be improved
- Negotiate and help problem solve the small doable action to be implemented
- Schedule and carry out follow-up visit

Always start with what is most easy and feasible for the client and the household!

► *Negotiate the SDAs to be implemented*

- The job aid helps the clinic and outreach workers remember the SDAs—the options to select from.
 - Show the counselling card you would like the client and household to try and choose an SDA based on his/her current practice and the ‘biggest leap toward the ideal’ that the household feels he/she can make.
 - Assess with the client what is needed to do the behaviour, and try to identify what might stand in the way of him/her practicing that behaviour. If the SDA is a skill to acquire such as treating water, drawing drinking water, etc., demonstrate and ask the client to try and give feedback.
- Ask:
- o What might make it hard to try ?? [a particular WASH practice, e.g., wash your hands with running water before cooking or feeding food ...]
 - o What might make it easier to ?? [WASH practice]
 - o Does anyone/do you anticipate anyone will disapprove of you spending time doing [WASH practice] instead of what you currently do?
 - Encourage the client and household members to try and continue to practice.
 - Get a commitment to try a specific SDA before closing the session or moving on.
 - Schedule a follow-up visit.

Step 3: Conduct a follow-up visit with the client and household members, or focus on the behaviour at the next visit

- Make a good contact with the client and household members
- Always check if it is a good time for the client and household to talk/discuss
- Ask the client to recall the SDA he/she and the household agreed to implement, and to demonstrate the behaviour if possible
- Ask if the client was successful in implementing the SDA, and revisit the questions ‘What made it hard? What would make it easier?’ if the client was not 100% successful
- Ascertain if the client is practicing the behaviour both consistently (every time) and correctly
- Help the client problem solve the constraints identified
- Encourage the client to continue to implement the SDA

Step 4: If the household/client has multiple WASH needs

- Follow up until the client successfully and consistently implements and adopts the improved WASH practice. Congratulate the client and ask him/her to continue to implement the behaviour consistently.
- Negotiate a second WASH practice to be improved using the appropriate counselling cards*
- Check the SDA to be negotiated for the second WASH practice and ensure the first behaviour is maintained.
 - Negotiate improving the second WASH behaviour and follow up on how the household implements the improved practice.
 - Continue to follow up on consistent implementation of the first improved WASH practice.

Small Doable Actions for Safe Disposal of Faeces: How to Build a Traditional Latrine on Stable Soils

1. Dig pit



Siting the latrine



Clear site



Measure site



Dig pit
0.6m wide, 0.9m long and
5m deep.

The pit should be dug:

- At least 10 metres away from kitchen or homestead
- 30 metres from water sources
- In the back of the dwelling house for privacy purposes

2. Masonry work

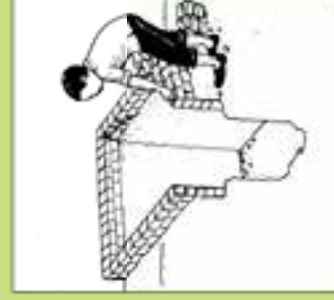

Create lining with
stone or bricks

Build 10 to 20 cm
mud masonry work
above the ground.



Put logs

Put wood or logs on
top of the pit and
make sure that the
wood or logs extend
50 cm beyond the
edge of the pit.

3. Make a pit cover, a squatting hole and superstructure



Put mud on the pit

Cover the logs or wood with
mud leaving squat hole of
about 12.5 cm wide and 25
cm long.

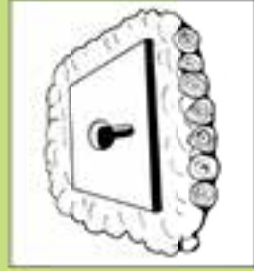

If possible, install
a SanPlat to make
the latrine easy
to clean and look
modern.



Superstructure

Then construct a
superstructure and a roof with
locally made materials and
plaster the wall with mud or
cow dung.

4. Prepare a latrine cover and hand washing station



Make latrine cover

Cut a piece of timber of 17 cm
wide and 30 cm long and in its
centre, fix a stick of about 50 cm
long with a nail to make a squat
hole cover.



Make a tippy tap

Hang the tippy tap on
the wall or poles or tree
outside.

Small Doable Actions for Safe Disposal of Faeces:

How to Build a Shallow and Hygienic Latrine in Rocky and Sandy Soils

1



Identify site for the toilet.

2



Clear the site.

3



Demarcate the area for the pit.

4



Dig pit of about 1 metre or less deep.

5

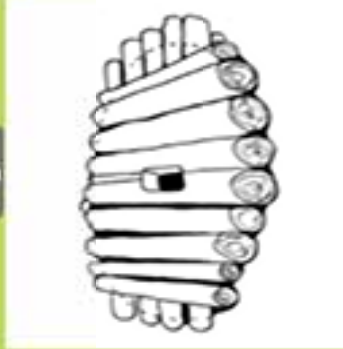

Put wood or logs on top of the pit and make sure that the wood or logs extend 50 cm beyond the edge of the pit.

6



Cover the logs or wood with mud, leaving a squat hole of about 12.5x25 cm. If possible, install a SanPlat to make the latrine easy to clean and look modern.

The pit should be dug:

- At least 10 metres away from kitchen or homestead
- 30 metres from water sources
- In the back of the dwelling house for privacy purposes

7



Construct temporary superstructure using bamboo.

8



Fix a hand washing facility with soap or ash. Pour ash in latrine weekly to reduce bad smell.

9



When the latrine is full, dig another pit nearby and transfer the superstructure and slab to the new pit. Cover the old pit with soil and plant a fruit tree into the full pit.

Benefits of composted pit waste



After one year (no less) the contents may be removed and the composted manure applied to a garden.



Handling fresh pit waste is a health hazard. Do not remove the contents of a pit before one year.

Small Doable Actions: Safe Disposal of Faeces

Negotiation Card

Put faeces of sick people, adults, children, babies, and animals (including birds) in a latrine.

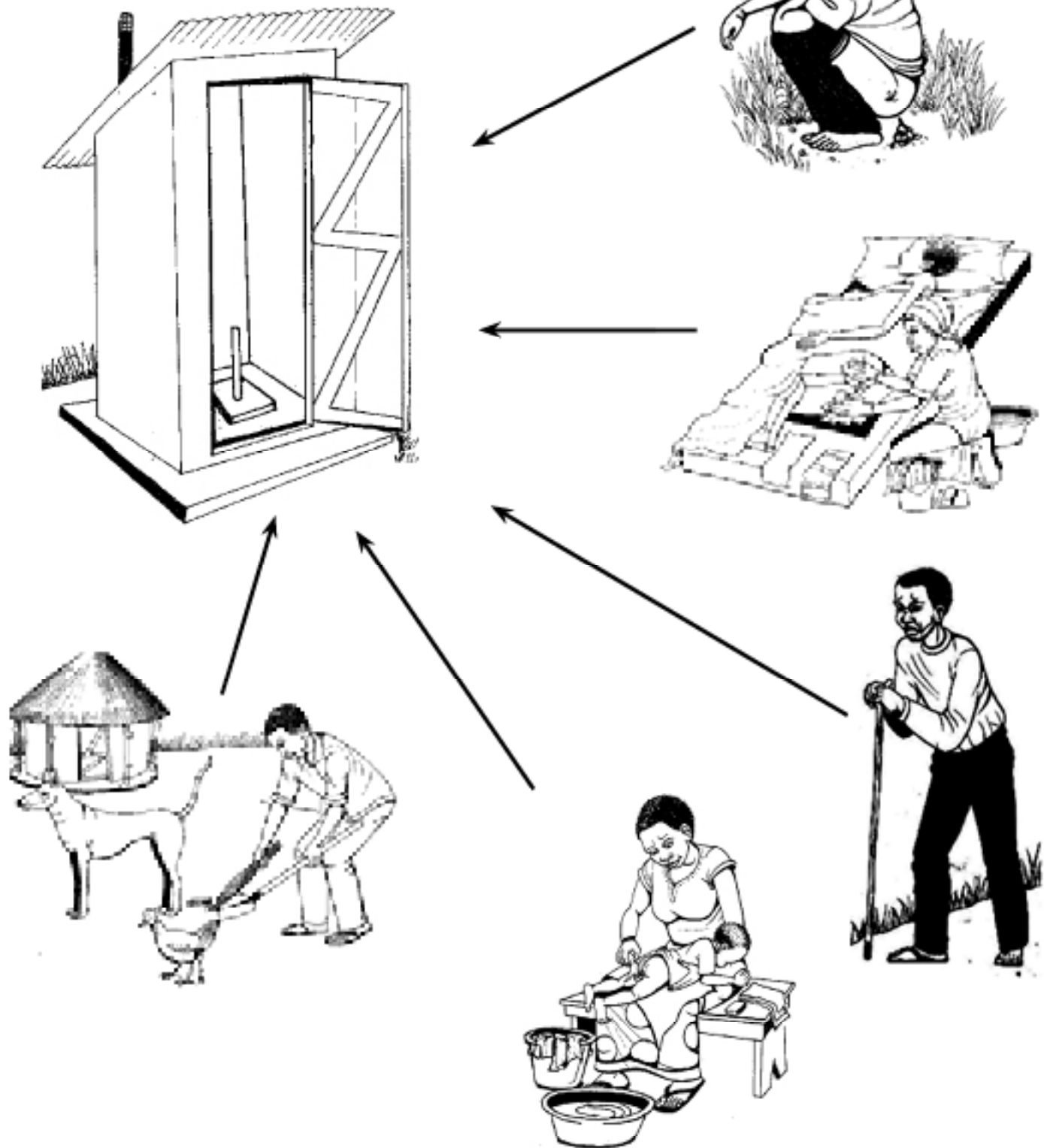

Negotiation Card

WEAK BUT MOBILE PERSON



Use walking stick.

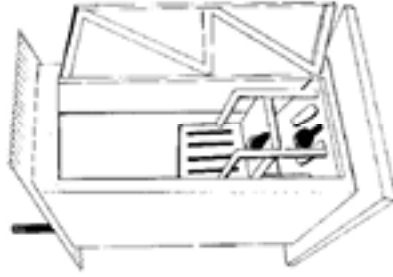

Cut hole in chair to help weak person use latrine.

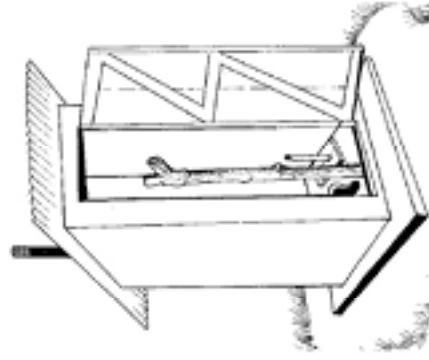

Add pole (or handles on wall) to latrine to help weak person squat or stand up.

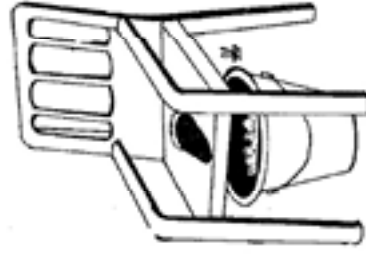

Put bucket under chair with hole in seat for indoor use.

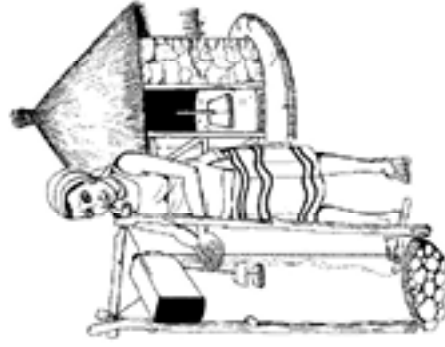

Put hand washing supplies near where sick person defecates.

BEDRIDDEN PATIENT



Put plastic sheet (mackintosh) with a cloth on top under sick person's hips. Change cloth when soiled.



Use potty (bedpan).



Put water, soap (or ash), and clean rags next to sick person's bed. Put a little ash in bottom of potty to make emptying and cleaning easier.

Small Doable Actions for Safe Disposal of Faeces: Making a Commode (Potty Chair)

Negotiation Card

1

Make a wooden stool or chair.

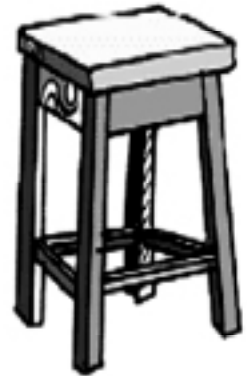

2

Cut an oval hole in the middle of the stool that “fits” the user (not too big, not too small). Smooth the edge of the hole to avoid bruising.



3

To use commode (potty chair):

- put a bucket beneath the hole in the stool/chair



OR

- put the stool/chair over the hole in the latrine.



Instructions adapted from “Making Adaptations Commode/Potty Chair,” Hospice Africa (Uganda).

Small Doable Actions: How to Wash Your Hands

Negotiation Card

1

Wet your hands and lather them with soap (or ash).



2

Rub your hands together and clean under your nails.



3

Rinse your hands with a stream of water.



4



Shake excess water off your hands and air dry them.

Critical Times for Hand Washing

BEFORE

AFTER



Preparing food



Feeding patient



Feeding baby or breastfeeding



Taking medicine



Eating

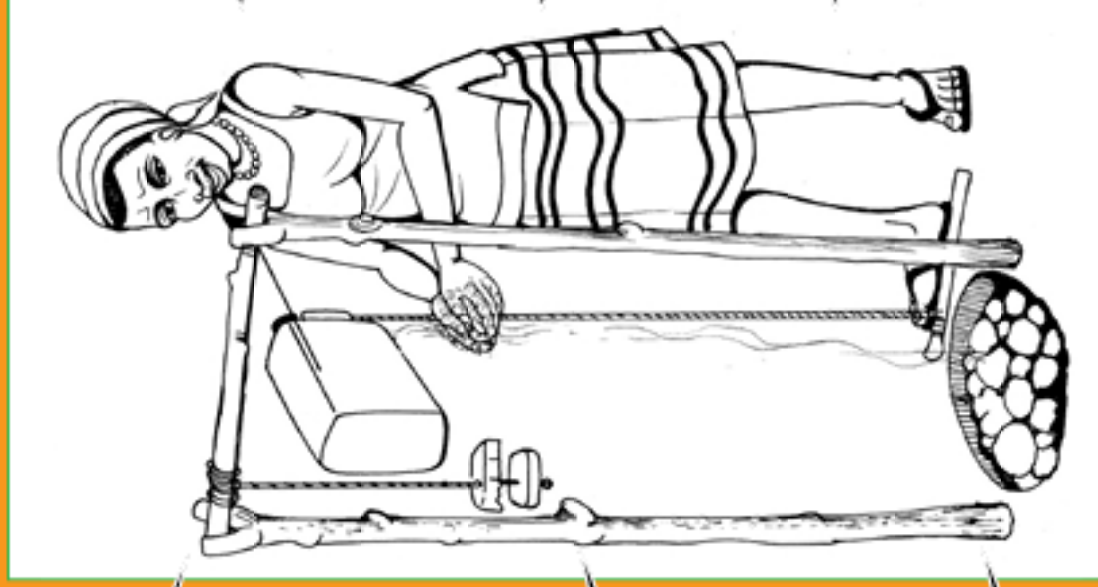

Cleaning child's bottom



Visiting latrine



Handling and disposing of children's, animals' and birds' faeces

Small Doable Actions for Hand Washing: How to Make a Tippy Tap

9 Tilting Jerry Can

Materials needed: A small jerry can with a lid (3-5 litres). 2 pieces of heavy string (60 cm) for hanging jerry can and (100 cm) for the pedestal. A thin string (60 cm) for hanging soap. Three poles, 1 suspension pole (80 cm), two standing poles preferably "Y" (150 cm). A mineral water bottle for soap protection.

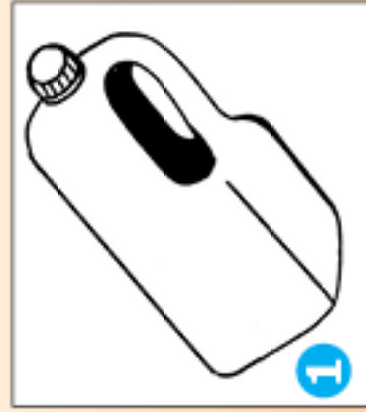

Get a clean empty jerry can.

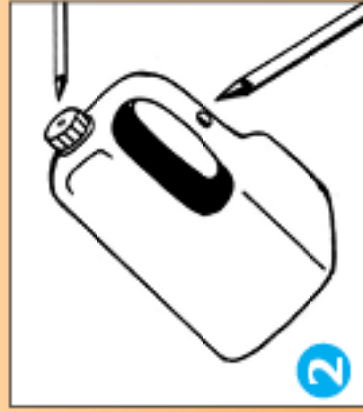

Using a nail, punch a hole on the lid for the pedestal string and at the jerry can handle for the dripping water.



Punch a hole for hanging string through the other side of the jerry can.

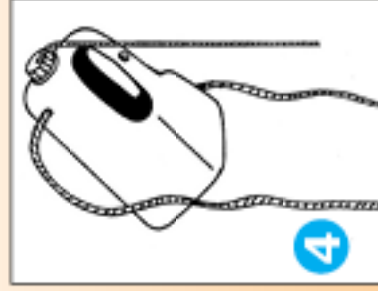

Place the hanging string through the nail holes and another string around the lid to attach to the pedestal.



Hang the jerry can on two fixed poles. Make hole in soap and cut the bottom off a mineral water bottle to use as a soap protector. Fix a string through them and hang on pole.

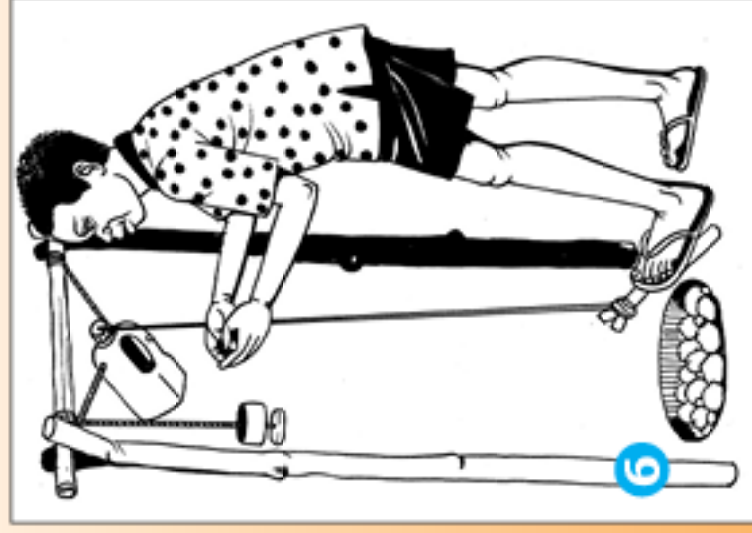

Tie solid stick to string attached to lid, long enough to reach about 10-13 cm from the ground. Step on the pedestal to tip water.
Put in place a soap pit by digging a shallow hole (60 cm wide and 30 cm deep).



Small Doable Actions for Hand Washing: How to Make Other Types of Tippy Taps

1 Mineral water bottle - 1

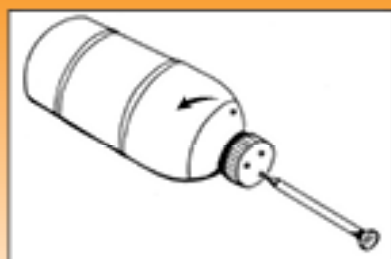

Punch a few holes on the mineral water bottle lid and one on the bottle to allow in air.

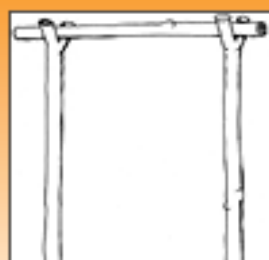

Fix poles.

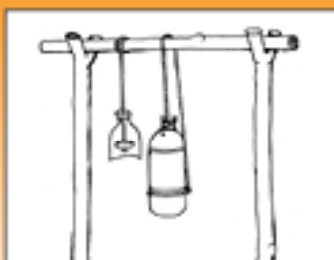

Hang bottle and washing soap on the fixed poles. Pour water in the bottle.



Use your elbow to tip the bottle facing down to allow water to flow.

2 Mineral water bottle - 2



Make a hole at bottom of the mineral water bottle.



Fix string for hanging at the neck of the bottle.

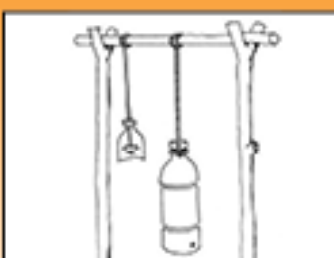

Hang bottle and washing soap on the fixed poles. Pour water in the bottle.



Loosen lid to allow water flow and tighten lid to stop water flow.

3 Tin can or leaky tin



Take an empty tin, turn it over and make around 10 holes.



Hang soap and the tin on the wooden poles.



Pour a cup of water in the tin.



Wash hands with flowing water from the tin.

4 Hollow tube: on gourd or jerry can or mineral water bottle



Make a hole toward the bottom of the container.



Insert hollow tube (pen, straw, casing, pawpaw stem) in the hole. a rubber band can be used as a gasket between straw and receptacle.



Fix plug in cover for the tube before you pour water in the container.



To start water flow, remove container lid or plug. To stop water flow, put tight the container lid.

Note: The tippy tap can hang from or be tied to a tree, pole or shelf.
Ensure that a soak pit is put in place for the different hand washing facilities.

Small Doable Actions: Taking Care of Drinking and Cooking Water

1 Transport

Carry your water home in a container with a lid



Small Doable Actions:

- Wash hands at source to avoid polluting new water
- Tie jerry can lid to container to avoid losing it
- Create a makeshift top with a clean potato washed each time at the source

2 Serving

Serve the water without letting anything that may be dirty touch it (such as your hands or a cup)



Small Doable Actions:

- Buy or make a ladle for serving and hang ladle on a wall
- Have separate cups for serving and drinking

3 Storage

Store water in a container with a tight-fitting lid

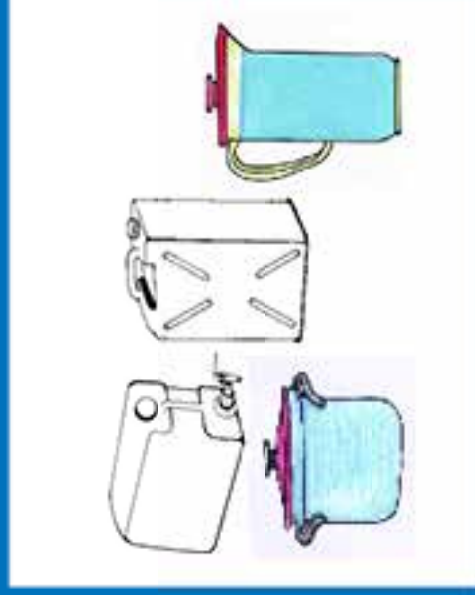

Small Doable Actions:

- Store container off the floor, ideally waist height for easy serving, to prevent contact with children and animals
- Select a container with a small neck or find a makeshift cover



Small Doable Actions to Make Water Safer to Drink: Cleaning Drinking Water Storage Containers

12

Wash the containers using water, soap or ash.

Small stones, sand or steel wire must not be used because they scratch the container leaving breeding places for germs. Rugs, grass or any other materials should not be used to clean drinking water containers, they can add germs that lead to contamination.

Washing water containers:

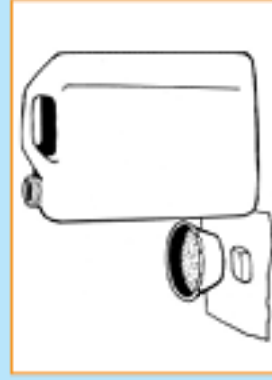

1. Put small amount of soapy water or ash in the container, shake the container and pour out the water. Small stones, sand or steel wire must not be used because they scratch the container leaving breeding places for germs. NEVER use a rag inside and NEVER insert your hand to clean.



2. Rinse the containers with water until there is no dirt, soapy water or ash.



3. Use a rag to scrub the outside of the containers with soap and water. Thereafter rinse them again with clean water.

4. Finally hang the containers, preferably on a rack, to allow them to dry.

5. Cover the containers tightly and keep them away from dirt.

There are 5 safe methods to make water better and safer for drinking:
WaterGuard | Aquatabs | Approved water filters | Boiling | Solar disinfection

Small Doable Actions to Make Water Safer to Drink: Boiling



1

- Collect water from water source.

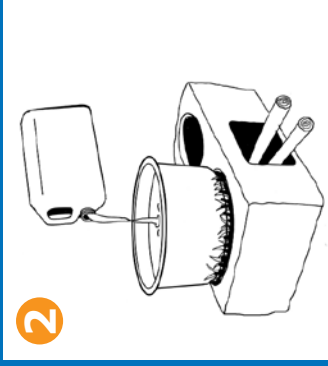

2

- Pour water into boiling container.

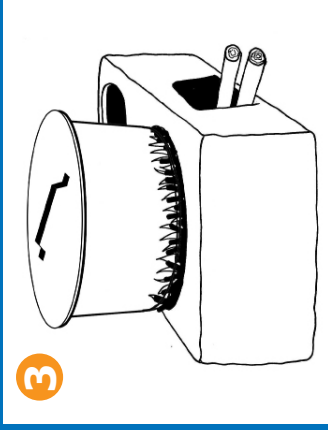

3

- Cover the water boiling container.

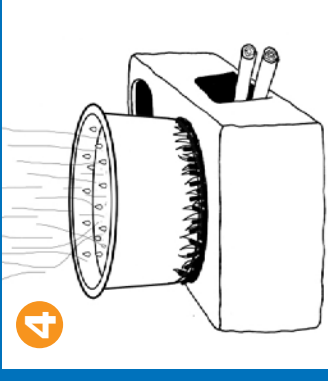

4

- Boil the water until large bubbles appear.

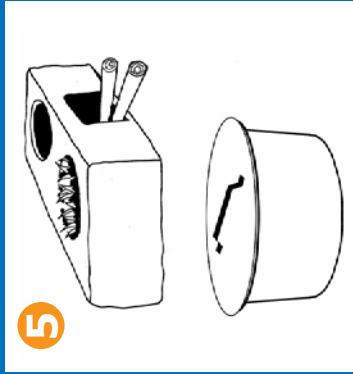

5

- Remove from fire and allow to cool. Do not remove lid to avoid contamination.

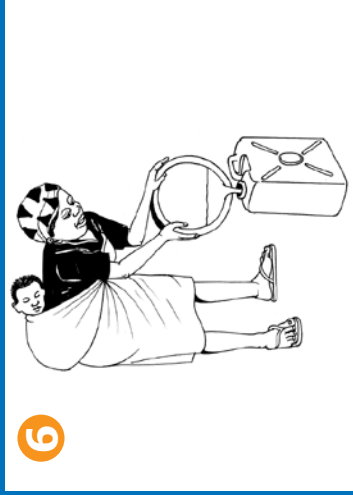

6

- Store boiled drinking water in containers with tight covers.



7

- Do not use the serving cup for drinking.

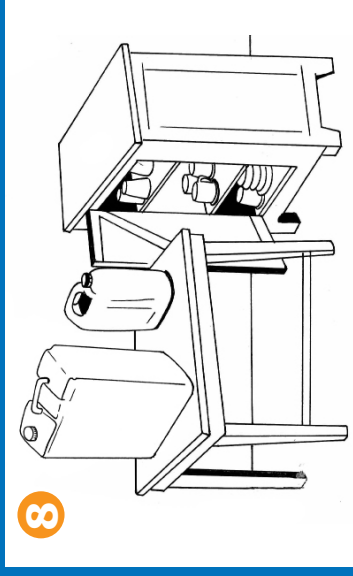

8

- Store drinking water in tightly covered containers, in a clean environment on a stool or table and away from children and animals.

Filtering and boiling

If the water is dirty, leave it for some time so that the dirt settles below the container. Clean this water by filtering. To achieve good results do the following:

- Get a clean cloth and clean container such as a bucket and place the cloth on top of the container.
- Carefully pour the settled water through the cloth into the clean container. Make sure the settled residue or dirt does not pour out.
- After filtering ensure that you boil your water to kill germs.

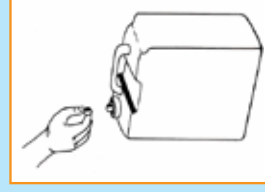
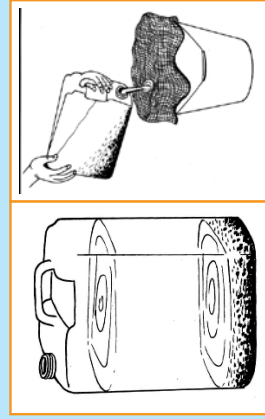

Treat drinking water

- Drinking water can also be made safe by adding purifying tablets such as Aquasafe or WaterGuard. Follow instructions on the label of the water purifier.



Small Doable Actions for Making Water Safe: How to Mix WaterGuard

Counselling Card

Does your water look clear?

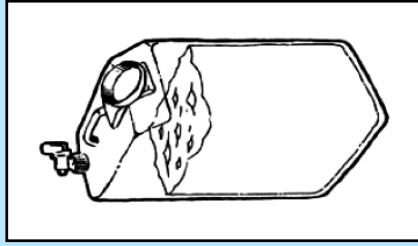

1

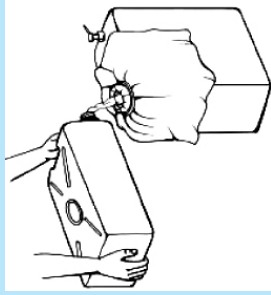

Filter the water through a clean cotton cloth.

2



Add 1 tablet to 20 litres of filtered water.

3



Wait 30 minutes.

4



Water is now ready to drink.

Does your water look Dirty?

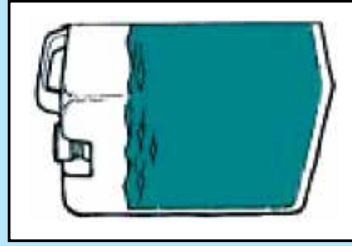

1

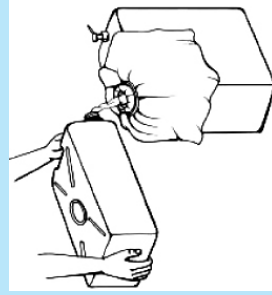

Filter the water through a clean cotton cloth.

2

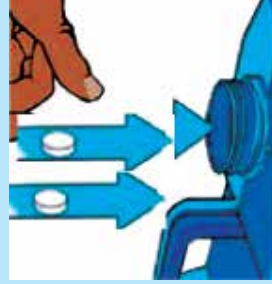

Add 2 tablets to 20 litres of filtered water.

3



Wait 30 minutes.

4



Water is now ready to drink.

Remember: Do not swallow tablets and store them away from children and sunlight. Water treated with WaterGuard that is stored in a narrow neck container with a tight fitting lid can be drunk for up to seven days. Treated water in a wide mouth container or without a tight fitting lid can be drunk for only 24 hours.

Small Doable Actions for Accessing More Water: Rainwater Harvesting Options

RAINWATER HARVESTING IS A SUPPLEMENTARY WATER SOURCE.

It is low cost and relatively easy to build, and provides an easy, free source of water. No walking for water!



Rainwater harvesting without gutters

This is not an effective option.

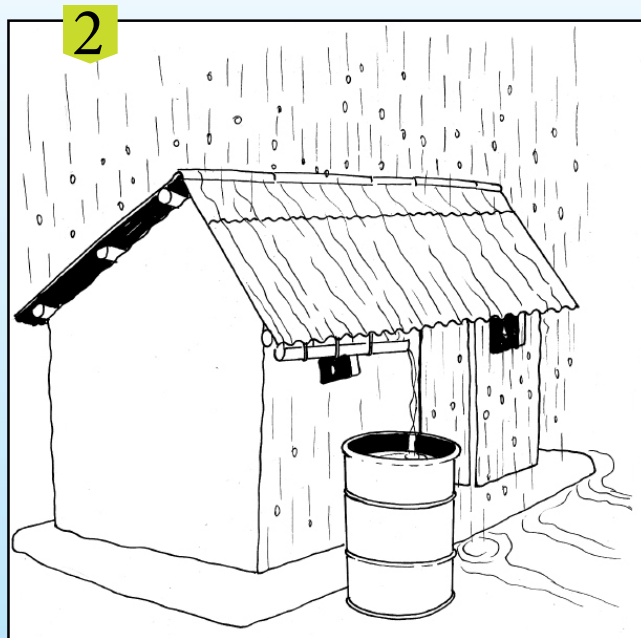

Rainwater harvesting in a drum using one gutter

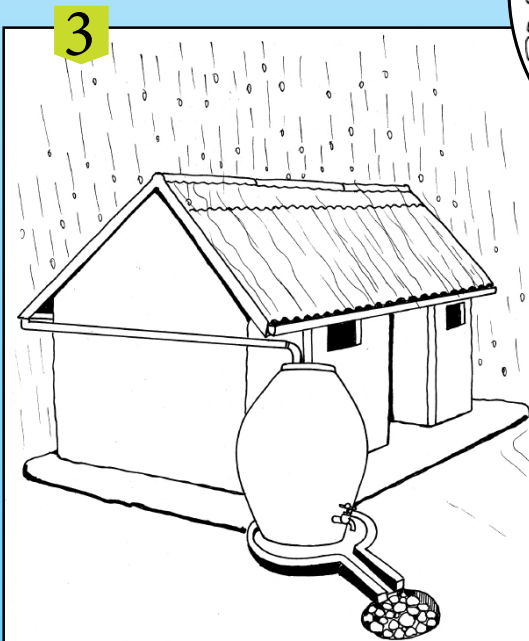

Rainwater harvesting with a water jar



Cut out iron sheets to make gutters and delivery pipe. Use wires to mount gutters onto the roof.

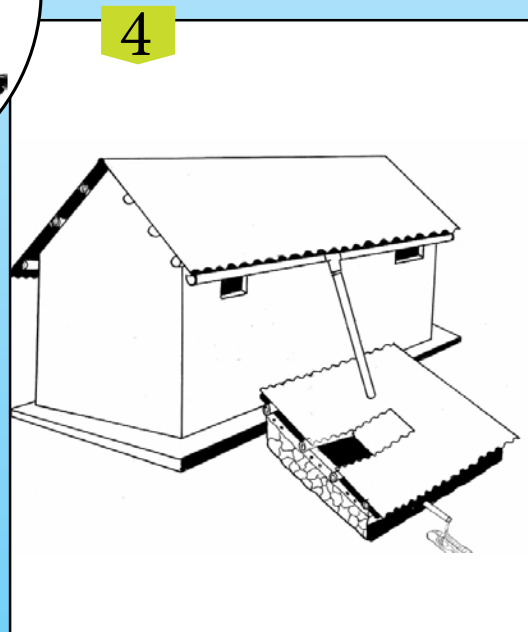

Rainwater harvesting with a cistern

Small Doable Actions for Accessing More Water:

How to Make a Rainwater Catchment Cistern on Your Own

16

REQUIRED MATERIALS: Corrugated sheeting | Tarpaulin | Gutter | Stones | 5 litre jerry can | Strong stick about 2 metres | Lock or safe closure to protect children | Tools for digging, hammering

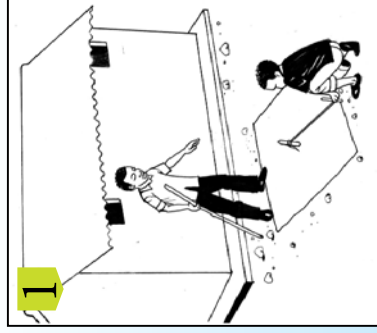

1 Plan everything before you start. Measure once, then measure again.

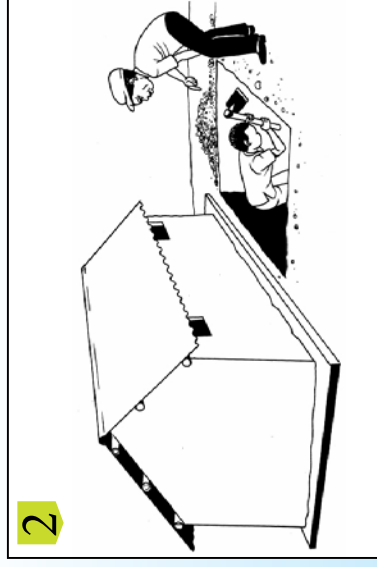

2 Dig a large hole, at least 2 m long, 2 m wide and 1 m deep. The size depends upon your land available and the size of your tarpaulin.

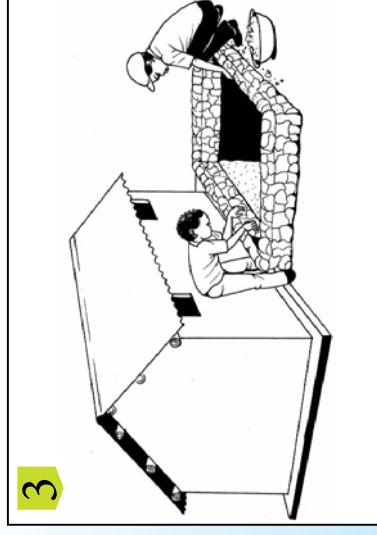

3 Build a wall around the perimeter, from stones and mud.

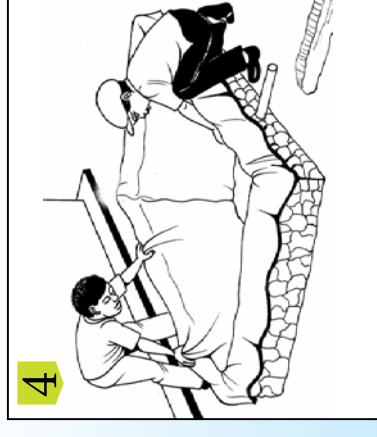

4 Line pit with a tarpaulin. Note how to finish/fix the tarpaulin.

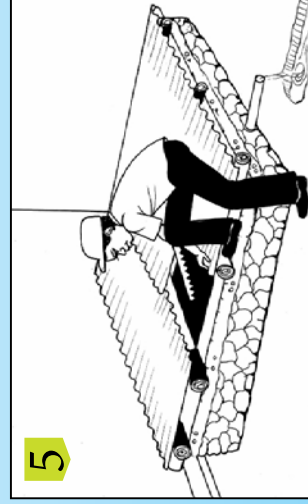

5 Make a cover for the pit by using iron sheets.



6 Cut out iron sheets to make gutters and delivery pipe. Use wires to mount gutters onto the roof.

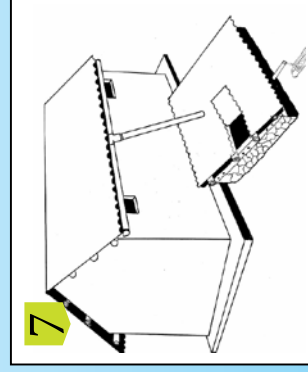

7 Finally fix the delivery pipe from the gutter to the cistern to have a complete rainwater harvesting cistern.

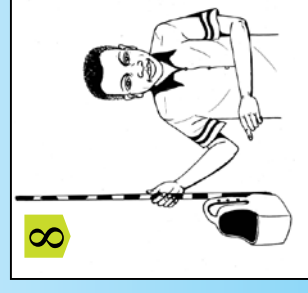

8 Make a DIPPER from a used 5 litre jerry can, a stick and strong nylon twine or nails.

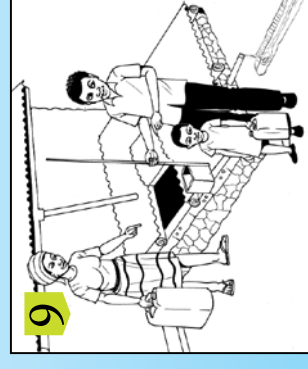

9 Always use clean containers to draw water from your cistern.

*Make certain that children cannot get access to play in the water, to dirty it OR TO FALL IN!!
Make certain chickens or other animals' faeces cannot contaminate the tank!*

Small Doable Actions For Keeping Food Safe: Food Handling and Preparation

It is especially important to wash hands and food containers with soap and flowing water before handling food to minimise the risk of germs. Adhere to all personal hygiene practices like keeping fingernails short while handling food.

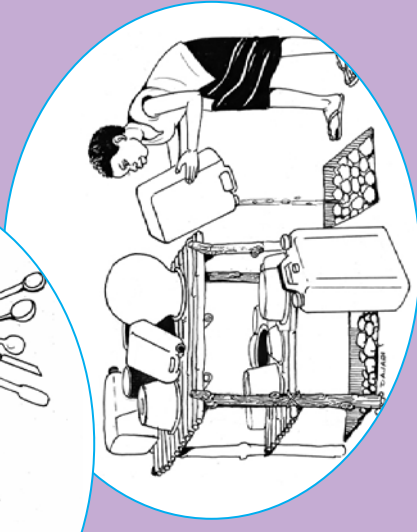
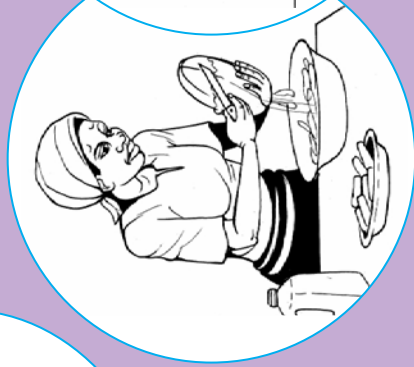
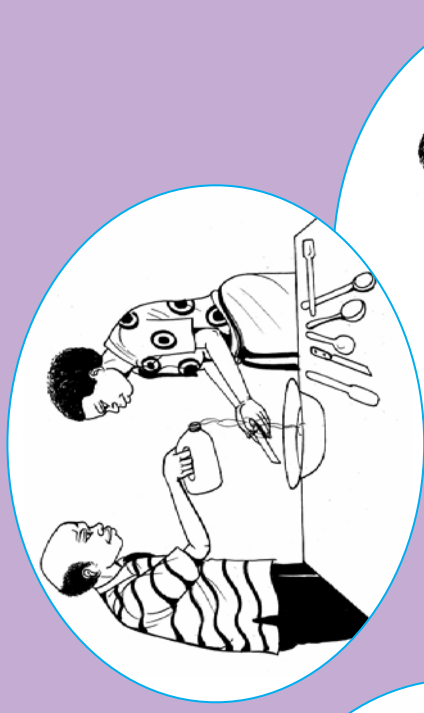

- ◆ Construct a tippy tap close to the kitchen to ensure hand washing with soap.
- ◆ Wash hands with soap before preparing food.
- ◆ Keep fingernails short and clean.
- ◆ Prepare raw meat or fish away from other raw foods. Don't allow juices to touch other foods.
- ◆ Wash area where food is prepared at least daily, with water and Jik, if available, otherwise soap.
- ◆ Wash raw vegetables and fruits under running water to remove germs, insects, and chemicals.
- ◆ Keep animals (such as chickens) away from food preparation area.
- ◆ Wash all the knives, cutting boards, and plates used after cutting fresh meat with soap and water.
- ◆ For utensils used to handle cooked and ready-to-eat food, wash with soap and water and store on shelf or wall.



USAID
FROM THE AMERICAN PEOPLE



THE REPUBLIC OF UGANDA
Ministry of Health



Supportive Environments for Healthy Communities

Small Doable Actions for Keeping Food Safe: Serving and Food Storage

It is especially important to wash hands and food containers with soap and flowing water before handling food to minimise the risk of germs. Adhere to all personal hygiene practices like keeping fingernails short while handling food.

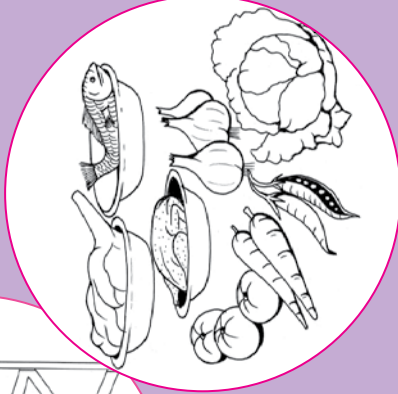
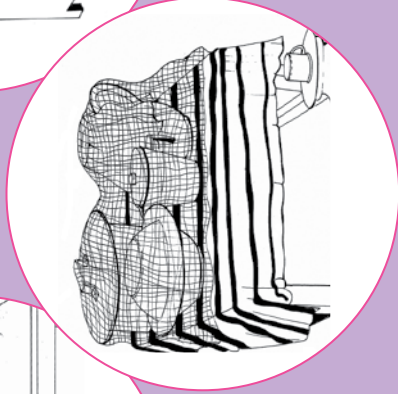
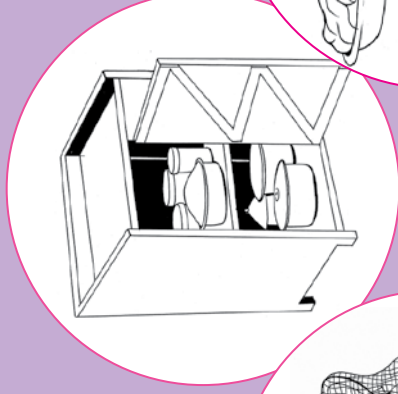
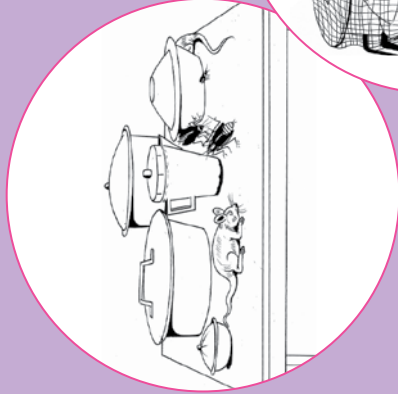
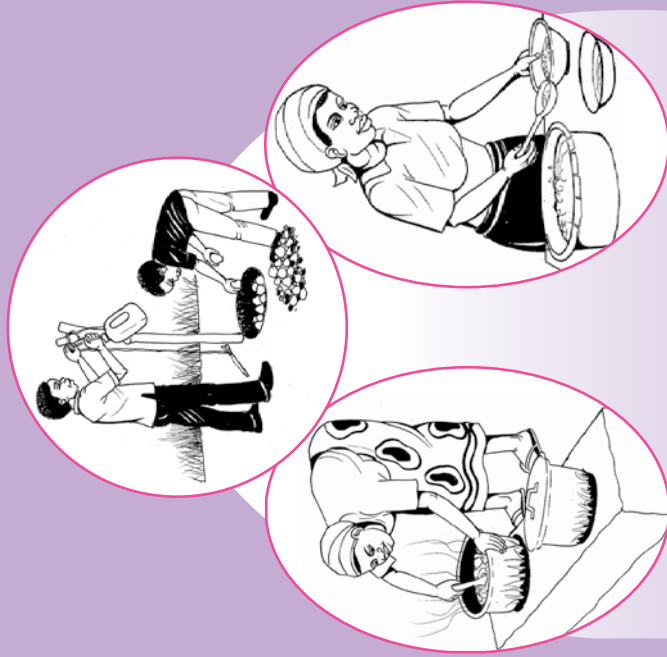

SERVING

- ◆ Wash hands with soap before serving food.
- ◆ Heat leftovers thoroughly until you see steam or bubbles. Stir to ensure they are heated evenly.
- ◆ Reheat leftovers only once then dispose.
- ◆ Cook all meat and eggs until boiled or well cooked throughout.

- ◆ Cover food with net, tray, or cloth to protect food from germs and flies.
- ◆ Store food on a high rack or shelf inside the kitchen area or inside a cupboard
- ◆ Construct a dish rack near dish washing area to dry and store dishes.
- ◆ Dedicate two or three rags or nets for covering food. Store with clean dishes and utensils.
- ◆ Cover hot milk with a net or cloth.

- ◆ Change covering cloth 2-3 times per week. Wash used cloths with soap and water.
- ◆ Store fresh and cooked food separately to avoid cross contamination.
- ◆ Store raw meat, poultry, fish separately from other foods in a bowl, plastic sack, or container.
- ◆ Wash raw fruits and vegetables with soap or Jik and water before storing them.



USAID
FROM THE AMERICAN PEOPLE



THE REPUBLIC OF KENYA
UNITY AND DIVERSITY

washplus
Supportive Environments for Healthy Communities

Small Doable Actions: Making Reusable Menstrual Pads

You'll need a sleeve of a heavy cotton fabric, and then several removable liners. Liners should be made of towel cloth or something absorbent. You can have liners of different thickness for different days.

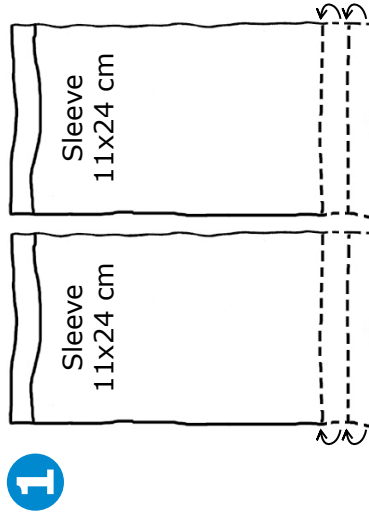

1

Cut two pieces of heavy cloth, 11x24 cm. Hem all four sides of short ends by folding 1 cm, then over again and stitching.

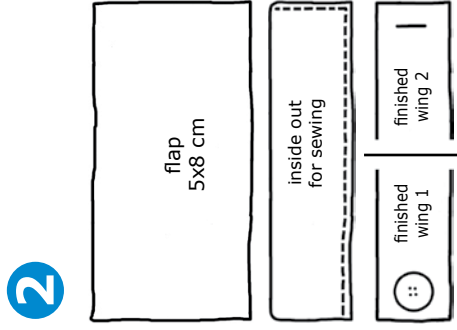

2

Cut two flaps, 8x5 cm, fold strips in half, sew on two long and one narrow side to make 'inside-out' wing. Turn right-side out, using a pencil or stick to help. Cut button hole in one side, and later sew button to other wing.

3

Place one piece of sleeve flat, then the two wings overlapping in the middle, then the second sleeve piece on top. Sew both long sides of sleeves, leave 1 cm seam making sure to keep the flaps perpendicular as shown. Turn right-side out.

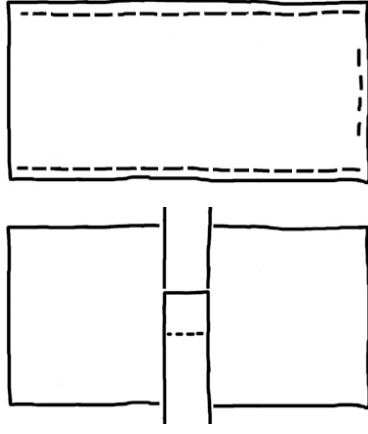

Sew about 3 cm at one of the short ends leaving enough room to insert a finger, then turn right-side out.

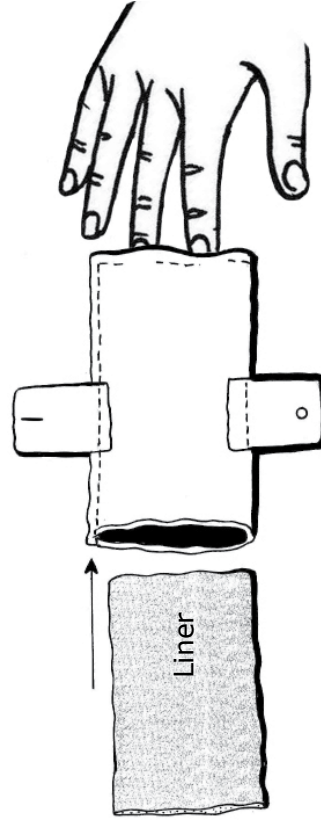

4

- Cut several liner pads of absorbent terry or other such material, 16 x 20 cm. Fold in half. Insert one liner inside, using the two finger hole gaps at far end to help guide and flatten the pad. • Sew button on outside of wing with button facing out for easy fastening. Cut and finish button hole on other wing.

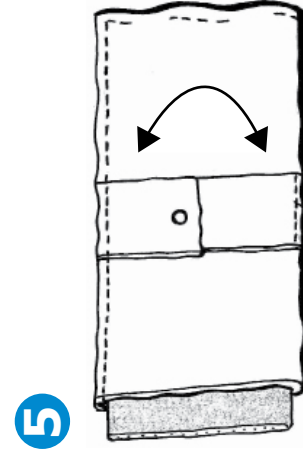

5

Affix to panty with wings and wear with confidence.

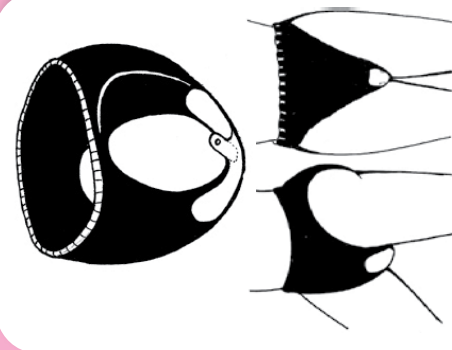

After use, separate, soak your pad in cold water and wash with soap, add JIK if available. Separate the pad from other materials. Hang it under the sun but don't hang under the bed, because it will get mouldy, which will cause itching.

Negotiation Card

Soiled cloth that **will not be used again** and sanitary pads and banana fibres should be disposed of by:

NOT REUSABLE

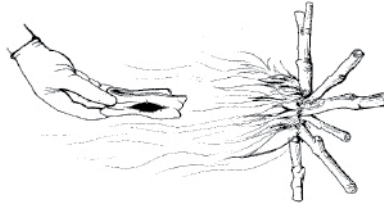

Burning (preferred method for urban and rural areas)

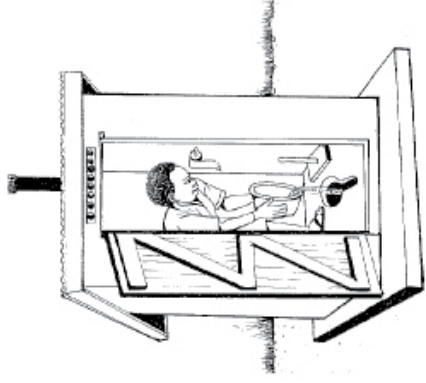

Put in latrine (rural areas only)

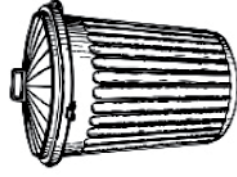

Double bagged and put in trash (least preferred method for urban and rural areas)

REUSABLE

Soiled cloth that **will be reused**. Wash as soon as possible. Do NOT store for more than a few hours, do not hide under bed, mattress or other place.

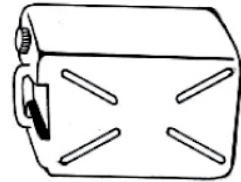
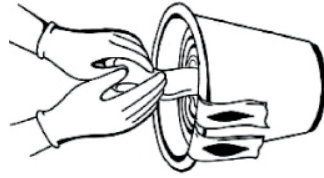

If possible, soak soiled cloth for at least 20 minutes in a mixture of nine parts water to one part Jik (if available)

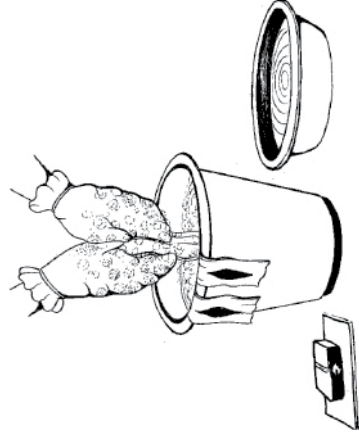

Wash with soap and water

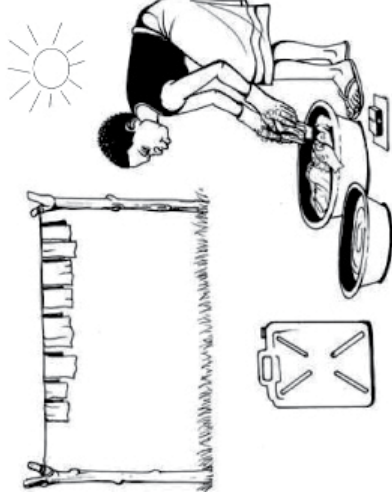

Dry in the sun

NOTE:

Always wear gloves or plastic material when handling blood and wash hands afterward.

